

A DOOMSDAY LIKE ANY OTHER

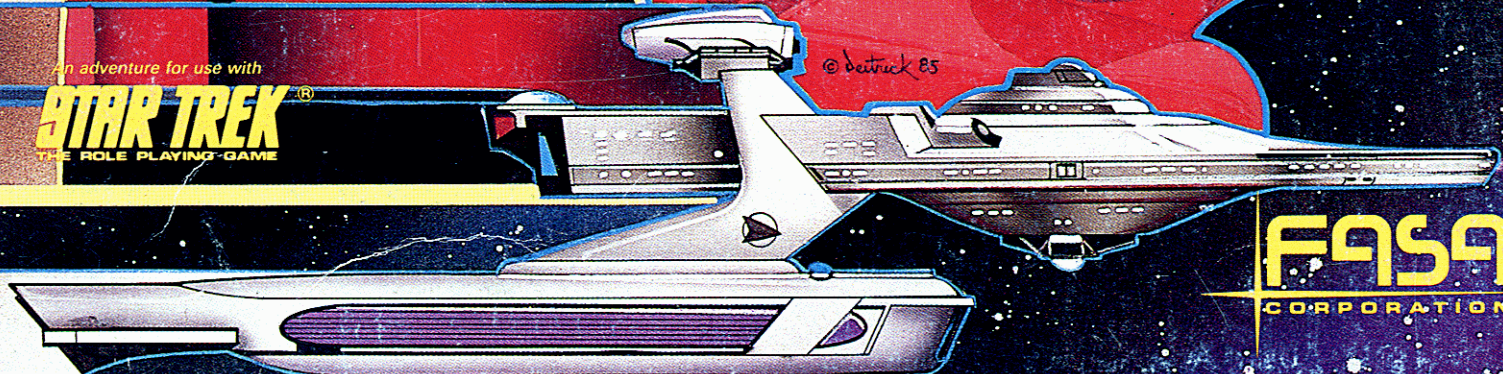

An adventure for use with
STAR TREK[®]
 THE ROLE PLAYING GAME

© Deitrick 85



FASA
 CORPORATION

A DOOMSDAY LIKE ANY OTHER

Original Design
Christopher E. Williams
Additional Design and Development
J. Andrew Keith
Design Assistance
L. Ross Babcock III
Forest Brown

Editorial Staff
Editor-In-Chief
L. Ross Babcock III
Senior Editor
Donna Ippolito
Editor
Todd Huettel

Production Staff
Production Managers
Jordan Weisman
Karen Vander Mey
Layout and Pasteup
Karen Vander Mey
Tara Gallagher
Dana M. Knutson

Cover Art
David R. Deitrick
Illustration
GIDEON
Dana M. Knutson
Typesetting
Karen Vander Mey
Tara Gallagher

Published by FASA Corporation
P.O. Box 6930
Chicago, IL 60680

STAR TREK is a trademark of Paramount Pictures Corporation.
STAR TREK: The Role Playing Game is published by FASA Corporation under exclusive license from
Paramount Pictures Corporation, the trademark owner.
Copyright © 1986, 1986 Paramount Pictures Corporation
All rights Reserved
Printed in the United States of America

Dedication:

To Commodore Matthew Decker, Star Fleet, who gave his life for the service.

TABLE OF CONTENTS

INTRODUCTION	2
Plot Synopsis	2
Contents of this Book	3
THE ADVENTURE	4
Introductory Story	4
A Ship In Danger	5
Doomsday Minus Three	6
The Captain's Choices	7
To Ectair's Aid	7
Diplomatic Approach	7
Kinglines Gambit	8
The Last Refuge	9
The Romulan Option	9
Aboard the Floating Crap Game	10
Rendezvous With Destiny	11
Initiative Lost	11
Second Chance	12
Enter O'Flaherty	12
Beacon of Hope	12
A New Problem	13
The Doomsday Bargain	13
Secret of the Beacon	14
Doomsday Intercept	15
Aboard the Machine	16
The Airlock	16
The Control Room	16
The Mind of the Planet-Killer	17
Buying Time	17
Triplecross	18
Outcomes of the Adventure	18
Combat on the Machine	18
Tal's Ploy	19
Runaway Planet-Killer	19
The Last Act	20
Back from the Brink	20
ECTAIR	21
Planetary History	21
Planetary Society and Culture	22
VESSELS	23
Chandley Class XI Frigate	23
Cosmos Royale Class X Liner	24
Dwarfstar Class II Freighter	25
V-6 Gallant Wing Class XII Cruiser	26
V-9 Night Flyer Class VI Cruiser	27
V-5 Skyfire Class VII Cruiser	28
S-9 Wind Carrier Class V Scout	28
Doomsday Machine	29
Shipboard Conditions	29
Room Descriptions	29
CAST OF CHARACTERS	32
Crew of the USS Fife	32
Player Characters	33
Secondary Officers	40
Incidental Crewmembers	41
Marines	42

The Romulans	43
Crew of the <i>Pride O'Rigel</i>	46
Ectairians	49
GAMEMASTER'S NOTES	50
Hints on Play	50
Adventure Flowchart	50
Clues and Clue-Dropping	50
Pacing	51
Adventure Flow	51
Adventure Outcomes	51
Skill Rating Bonuses	52
Adapting to Ongoing Campaigns	52
Special Game Considerations	52
Doomsday Deadline	52
Boarding Party Size and Composition	53
Negotiating	53
Gamemastering NPCs	53
Using the Players' Handout	54
Gamemastering Romulans	54
The Romulan Character	54
Commander Tal	54
Special Modifiers for Judging Romulans	54
Space Marines	55
Random Encounters	56
Cosmos Royale Encounters	56
Doomsday Machine Encounters	57
The Doomsday Machine	58
Origins	58
The Beacon Pod	58
Machine Behavior	59
PLAYERS' HANDOUT	60
Doomsday Machine	60
Specifications	60
Origins	60
Star Fleet Advisory	61
Ectair	61
IFF Transponder	61
Kinglines	61
Kirk Defense, The	61
Neutronium	62
Outback, The	62
Treaty of Ectair, The	62
Extract from the Command Orders for USS Fife	62
Appendix C - Intelligence Summary, Romulan Activity, Sectors SE/1-4/8-9	63
Goals and Objectives	63
Presence	63
Appendix E - Intelligence Summary, Gorn Alliance Activity, SE/1-4/8-9	64
Goals and Objectives	64
Presence	64
Appendix H - Star Fleet Command, Bureau of Foreign Relations, Guidelines: Ectair	64

INTRODUCTION

A Doomsday Like Any Other is an adventure module for use with *STAR TREK: The Role Playing Game*. In it, the Captain and crew of a Federation starship are faced with a gigantic, planet-crushing Doomsday Machine, very much like the one destroyed by the *USS Enterprise* in the *STAR TREK* episode "The Doomsday Machine". This adventure, however, poses new and more difficult problems for Star Fleet officers to overcome. The Machine's target, a neutral trade world near the edge of Federation space, has trade agreements with both the Federation and the Romulan Star Empire. The presence of Romulans complicates efforts to destroy the Machine, especially when the Star Empire makes a bid to harness, rather than eliminate, this great engine of destruction. In the long run, the key to success or failure lies not with Star Fleet or the Empire, but with an engaging but unscrupulous rogue who has stumbled across the secret of how to board, and maybe control, the Machine.

The adventure is designed for a group of four to six players, who take the roles of senior officers aboard the *USS Fife*, a *Chandley* Class Federation frigate. The gamemaster can adapt the scenario to additional players, and he can select another ship type if he wishes to fit the adventure into an ongoing campaign. A *Constitution* Class starship is the smallest vessel that should be allowed for this scenario, however.

Players may also choose to become characters other than Star Fleet officers. They may be the free-trader crew of the *Pride O'Rigel*, for example, or Romulans seeking to seize the Doomsday Machine for themselves. It is even possible that more than one group of player characters might compete in this adventure, with each group representing a separate force with an interest in the Doomsday Machine. Such an adventure would require a lot of work by the gamemaster, but could be a fascinating way to explore the situation to the fullest. These options are briefly explored later in this book.

PLOT SYNOPSIS

The *USS Fife* is on a routine patrol of the Federation's Outback area, a region of space facing that indefinite boundary between Romulan and Gorn space territories. The frontier has been quiet of late, with no hint of Gorn activities and only a few traces of Romulan expeditions into the unexplored regions beyond Federation space.

Then, **A Ship in Danger** disrupts the routine. A small trading vessel, the *Pride O'Rigel*, calls for help. It has stumbled across a Doomsday Machine in space, and is now being pursued. Over intermittent radio interference, it becomes clear that the trader is fast enough to escape but needs to make emergency engine repairs. It is up to the crew of the *Fife* to buy time without getting caught by the behemoth's tractor beams or its awesome weaponry. Once the trader is repaired, both ships hasten to the independent trading world of Ectair, in the star system projected as the Machine's next target.

At Ectair, it proves impossible to evacuate the population, nor is there time to improvise a defense. Depending on **The Captain's Choices**, the *Fife's* officers may be able to exercise enough influence locally to set up the one sure measure that can stop a Doomsday Machine — the so-called Kirk Defense, which requires the explosion of a starship's warp engines inside the mouth of the Machine. The presence of a Romulan merchant ship may either complicate or help their efforts, but in the end, the Kirk Defense fails. Ectair's only hope for survival seems lost.

The player characters do get a **Second Chance**, however. Patrick O'Flaherty, the *Pride O'Rigel's* Captain, reluctantly comes forward with startling information. When he first discovered the Doomsday Machine, it lay quiescent in deep space, orbited by some kind of small satellite. After the trader took the satellite aboard as

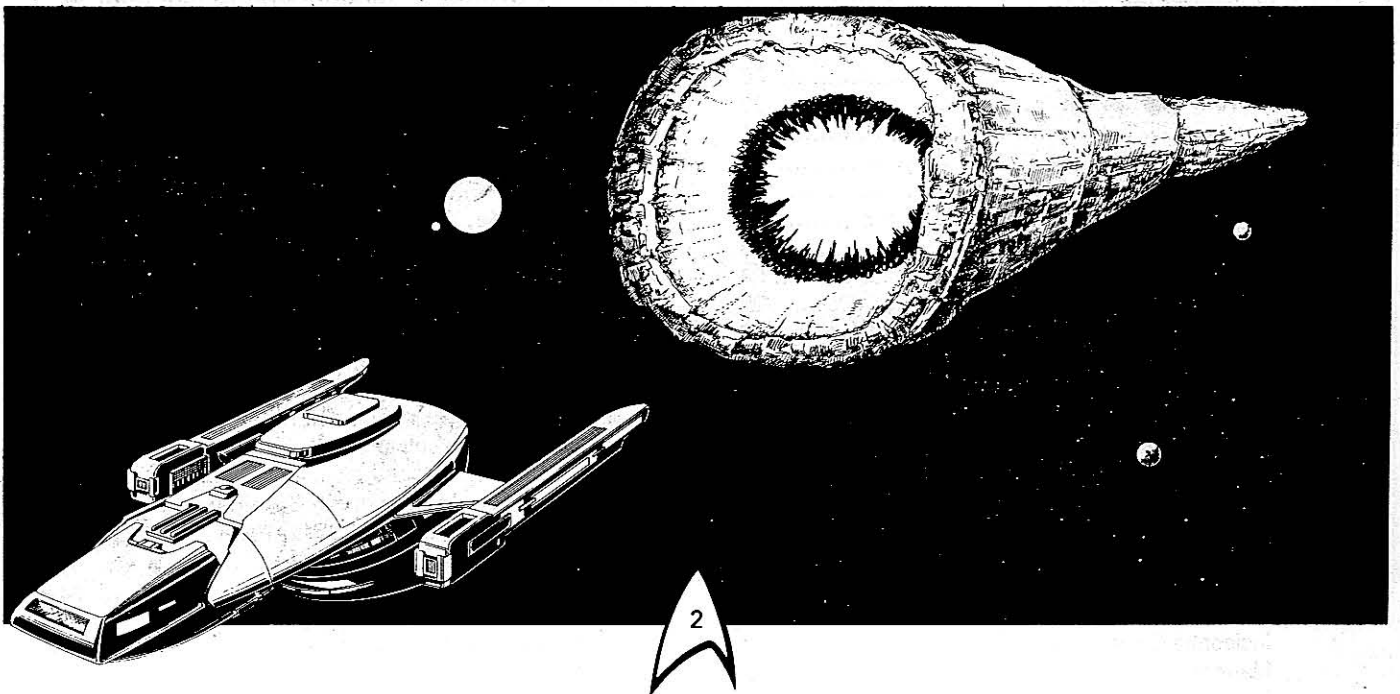

salvage, the Machine 'woke up' and moved against the trader ship. From this story, the players' group sees the possibility of shutting down or controlling the Machine rather than destroying it. Both the traders and the Romulans (now backed up by a squadron of warships) insist that any **Doomsday Bargain** be a cooperative one. O'Flaherty wants salvage rights on the huge ship, and Romulan and Star Fleet officers distrust one another with the key to such a powerful weapon of war. Working together, the three groups get **Aboard the Machine** and have a chance to disconnect the computer controls that guide it.

Treachery, however, is the order of the day, as both the Romulans and O'Flaherty make bids to take control of the Doomsday Machine for themselves. The three separate groups battle each other on board the Machine while, outside, the Romulan squadron threatens to destroy the *Fife* unless the Machine is turned over to them. In a difficult and dangerous showdown, the player characters must win the battle by harnessing the power of the Doomsday Machine to offset the overwhelming odds enjoyed by the Romulans.

CONTENTS OF THIS BOOK

All the information needed to run this adventure is contained in the section entitled **The Adventure**, which describes the events and situations that unfold throughout the course of the adventure. The **Ectair** chapter contains complete information on the planet Ectair, including its history, culture, and society. Following this is a list of the **Vessels** that take part in this adventure. Full statistics are given for the ships in case of starship combat.

The **Cast of Characters** chapter includes pre-generated characters suitable for use as player characters, and various important NPCs who figure in the adventure. Following this is the **Gamemaster's Notes**, which contains aids for creating and developing the adventure, for regulating encounters and events, and for properly role playing the actions and attitudes of various NPCs.

The four-page **Players' Handout** bound into this booklet summarizes the background information available from shipboard computers. This section is the only portion of the adventure that should be made directly available to the players, and then only when their characters would logically have access to computer files. In some cases, the players' information may differ from the notes given to the gamemaster, being either incomplete or inaccurate. In all cases, the gamemaster's information (and his interpretations) are the final word on any subject.

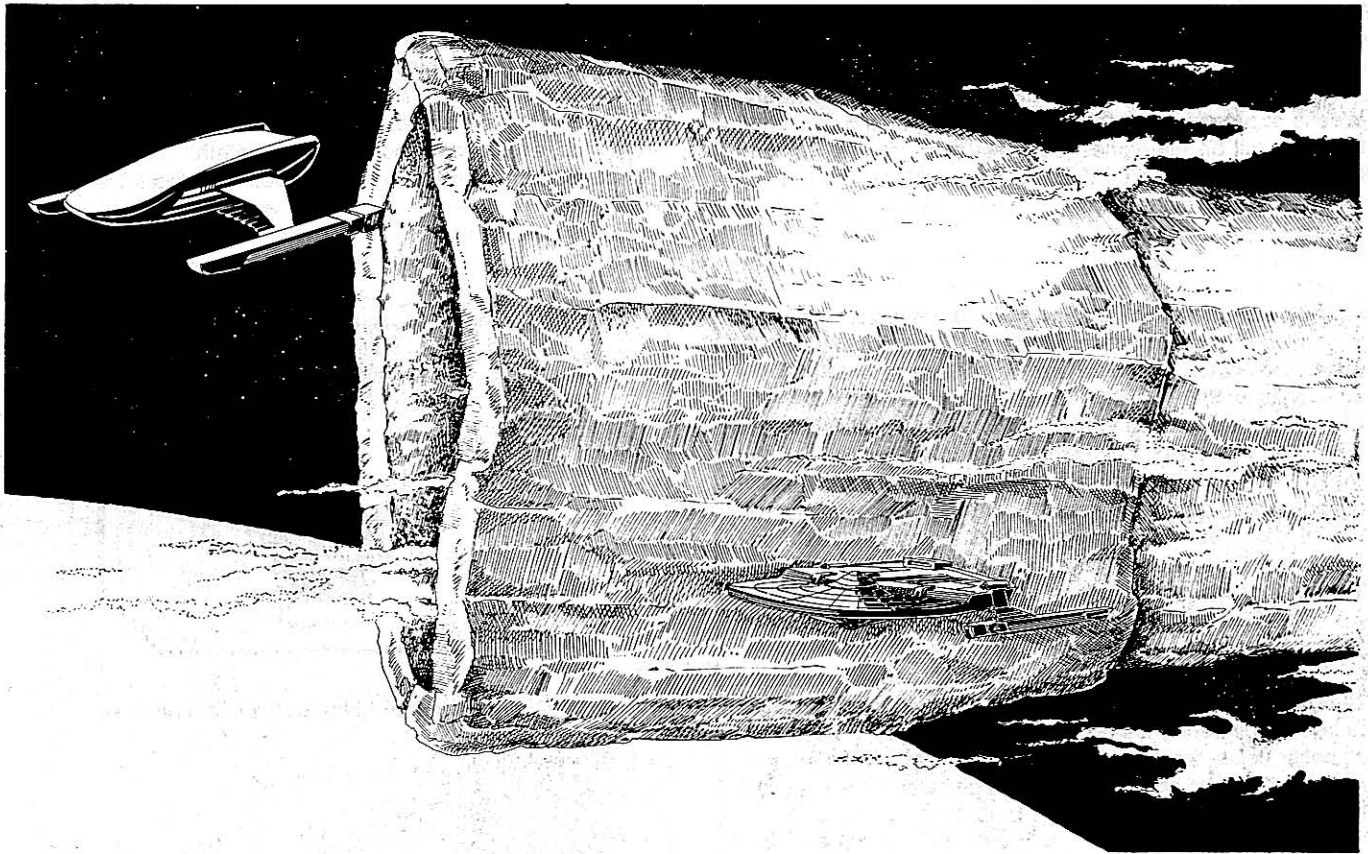

THE ADVENTURE

INTRODUCTORY STORY

Captain's Log, Stardate 2/2306.03:

"*USS Fife* on patrol near the frontier region between Romulan and Gorn territories. In nine weeks of patrol duty, there has been no sign of the hostile Gorn militarists rumored to be operating along this border. Best estimates by the Tactical Staff now indicate that the likelihood of Gorn operations in this sector has dropped to less than 15 percent.

"A few garbled messages intercepted from beyond the frontier suggest that Romulan forces may be operating in the region. Are they trying to circumvent the Neutral Zone and establish military bases on this border, or is it, as official Romulan accounts claim, merely a drive to explore space away from the Federation and the Klingons? If the latter, what will happen if the Romulans make contact with the Gorns?

"The more I see of this frontier region, the more I believe this region may be more dangerous than any of the troublespots closer to the Klingon/Romulan heartlands. Worlds such as Ectair, only two parsecs away from our current position, remain independent of the Federation and perfectly willing to do business with the Romulans. What good is the Neutral Zone if a Romulan squadron can simply go around it and find a friendly port inside Federation boundaries?"

Captain Jason Culver released the record button and leaned back in his command chair, suddenly feeling weary. Weeks of patrol with nothing in sight and nothing to do had taken its toll on everyone. Just last night, Ship's Surgeon Davenport had remarked that the *Fife* might well be the first starship in Federation history to have a mutiny out of sheer boredom.

The monotony weighed heavily on everyone, but the Captain seemed to feel it most. It showed in his pessimistic log entries, where he mused on Romulan plots and Gorn wars in a stretch of space where nothing ever happened. Maybe he *wanted* trouble here, something to break up the dull weeks that remained on their long patrol.

What had happened to the glory days of Star Fleet, he wondered. Kirk, Spock, Garrovick, Wesley, and all the great Star Fleet legends always seemed to find plenty of action and adventure to keep them busy. Kirk could get in the middle of things on a training cruise aboard an outdated ship crewed by raw recruits! Some people had all the luck. The *Fife* just drew the milk-runs and the survey cruises.

The Captain glanced at the duty officer at the Science Station. "Status report?"

"All normal, Captain. No unusual sensor contacts. Navigation fix places us 1.89 parsecs from the planet Ectair. Engineering systems check normal..." The young officer's voice went on, reciting a litany of department reports. All they added up to, though, were three words: Nothing to report.

"Captain?" That was the Communications Officer. Talk about boredom — except for filing reports with Star Fleet, Communications had not even had a chance to open hailing frequencies lately.

He cut off the duty officer. "What is it, Lieutenant?"

"I'm picking up a distress signal, Captain. Intermittent signal disruption makes it hard to decipher, but..."

"On audio, Lieutenant."

The speakers crackled with static, and the whine of signal oscillation filled the bridge. Then, some words cut faintly through the interference. "...any ship...in danger...this is trader...*O'Rigel* calling...hostile vessel...huge...we can't ...engines failing...need assistance. Repeating: To any ship...danger of attack. This is...*Pride O'Rigel*...under attack by..." A burst of static drowned out any further contact.

The Communications Officer stabbed another control, then shrugged helplessly. "They're still signalling, sir, but I can't bring in anything clearly."

The Captain nodded. "Keep at it. Can you lock in on the source of the transmission, Ensign?"

The duty officer bent over the science console. "Yes, sir. On line now."

"Navigation, lay in an intercept course. Helm, maximum warp. All hands, go to alert status."

The klaxon sounded the alert. Responses came in from each post as the frigate surged toward the vessel in distress.

Pulling his chin thoughtfully, the Captain leaned forward in his seat to study the trace in the navigation tank. An old saying his grandfather had been fond of popped into his mind, and he repeated it under his breath.

"Be careful what you wish for. You might get it."

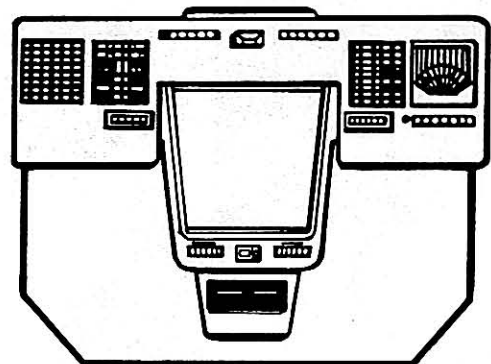

Navigation And Navigation Subsystems

A SHIP IN DANGER

As the *Fife* approaches the coordinates of the vessel in distress, sensors detect two objects ahead in deep space, both of them moving under power. The smaller of the two proves to be a conventional ship, a trader of the *Dwarfstar* Class. At this range, the vessel's transponder code can be picked up clearly, identifying the ship as the Free Trader *Pride O'Rigel*. The trader ship's engineering section is scarred by energy burns that might have been done by a light, ship-mounted phaser. Although the vessel is moving, sensor readings show that the trader is rapidly losing power.

The second object is immense: an uneven-surfaced cylinder over one-and-a-half kilometers long, its immense maw glowing redly with power. The tiny *Pride O'Rigel* is barely noticeable beside this vast object, which moves ponderously in pursuit of the trader ship. Sensor readings indicate that the hull of the behemoth is made of collapsed neutronium, which blocks all sensor readings of the interior. From the distortion of subspace communications and the few possible sensor readings of the intruder's motive power and energy source, it is evident that the thing is powered through the total conversion of matter to energy. Using computerized isotope dating methods, the Science Officer can estimate its age to be some three billion years.

Most players will recognize this object as a Doomsday Machine, a planet-crushing engine of destruction launched in a war of annihilation by a distant race. The *Enterprise* defeated a device of this type during its famous five-year mission. Even if the players do not recognize it, however, their characters might. Each character should make a Saving Roll against his INT score to recognize the Doomsday Machine, enabling him to call up computer records on the gigantic weapon. The **Players' Handout** contains the information on the Machine that is available to Star Fleet.

As the *Fife* closes with both vessels, it receives incoming communications from the trader. If transferred to the viewscreen, the image of a tousle-haired young man with a fresh, open face and a disarming grin forms. Despite his devil-may-care pose, however, he is clearly scared of the thing pursuing his ship.

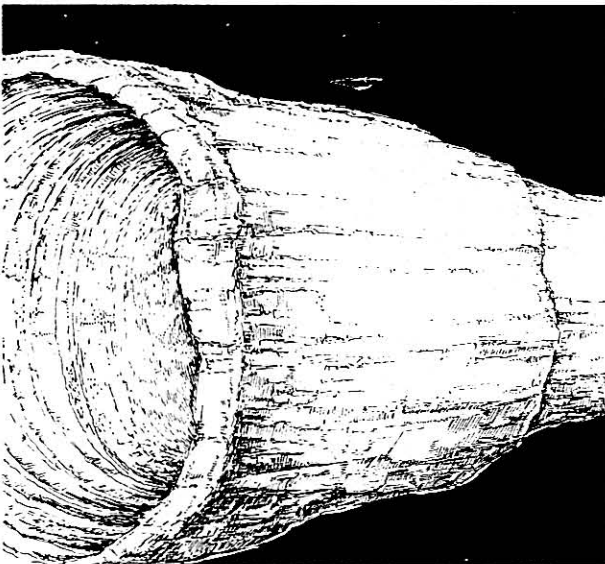

"Hello, Star Fleet," the man begins. "Glad you laddies could join the party. This is Captain Pat O'Flaherty of the *Pride O'Rigel*. We've got ourselves a spot o' trouble here. Can you lend us a hand before that big boyo breathin' down me neck has me ship for a snack?"

The trader goes on to describe his position. One of his ship's engines has been damaged (he does not say how), and if he does not shut it down soon, the whole system will give out. Right now, he is outdistancing the Machine, but it will certainly catch up if he shuts down. From everything O'Flaherty says, it is clear that he believes the Machine is chasing his vessel. Rather unusual behavior, according to Star Fleet analysis.

The machine is, in fact, pursuing the most direct course toward the nearest star system and the planet Ectair. The *Pride O'Rigel*, also on course for Ectair, can escape if she simply changes course and remains outside the critical range at which the Machine reacts to ships and other objects. The fact that O'Flaherty has not realized this should tell the players something very important: his crew has not observed the Machine in action over any length of time, nor did they happen to intercept the giant ship at random. The Doomsday Machine always travels by the shortest route possible between planetary systems, and changes course only when it detects a nearby object large enough to be worth consuming. If the *Pride O'Rigel* had entered that zone, she would never have gotten free again. There are three possibilities: O'Flaherty may be extremely inept not to have tried evasive maneuvers, he may have coincidentally chosen a course that made it seem as if the Doomsday Machine was in hot pursuit, or he has some reason to think that the weapon is following him (which is the actual case). The players should be able to come to the above conclusions by applying their knowledge of Machine behavior. The gamemaster may give the players hints, but it is more fun for the players if they figure it out for themselves.

It is possible that the players will not realize that a simple evasive move is enough to place the *Pride* out of harm's way. They might choose to use the *Fife* to distract the Machine, giving O'Flaherty time to make his repairs. If so, the Machine behaves with normal programmed responses. It will turn to face any object that moves to within 3000 kilometers, using a tractor beam to lock onto and consume the object. Each time a vessel passes within that distance, have the Helmsman make a Skill Roll against his rating in *Starship Helm Operation* to avoid being snared. If using shuttlecraft to divert the Machine, have the pilot make a Skill Roll against his rating in *Shuttlecraft Pilot*.

As the ship resolves each pass, the gamemaster should make a secret Skill Roll against the *Pride O'Rigel's* Chief Engineer's rating in *Astronautics*. Five successful rolls are needed to complete engine repairs. If the players choose to go through this totally unnecessary exercise, the gamemaster should stress that the Machine changes course as expected, and always returns to its original heading when the distracting ship passes out of the Machine's range. Should a *Starship Helm Operation* roll fail, the player characters are definitely in trouble, unless O'Flaherty decides there is profit in distracting the Machine long enough for the *Fife* to escape. The gamemaster can do this if the player characters become hopelessly trapped.

The Machine will not use its anti-proton beam during this encounter. Whether it be the *Pride*, probes, or unmanned shuttles rigged for the job, a ship that maneuvers to face the maw of the Machine can take sensor readings on the interior of the planet-killer. These will show that power levels are far below those recorded for the Machine defeated by the *Enterprise*. This is important, but again, player characters must compare the readings themselves to learn anything. O'Flaherty is far too busy to take sensor readings without a direct request. Remember that a vessel can move across the maw in safety as long as it remains outside the Machine's response limit. However, the experience is rather unnerving. If only for morale purposes, safety-conscious captains would be well-advised to use unmanned craft for the job.

This encounter is only a prelude to the real action. Once the safety of the merchant ship is assured, the gamemaster should nudge the player characters into the next phase of the adventure. The *Pride O'Rigel* is too small to be used for the Kirk Defense.

Everything should point to Ectair as the Machine's next destination. The *Pride*, her engines repaired, will also head that way. If possible, the player characters should warn and evacuate the populace. There is also a good chance that there will be a suitable ship for attempting the Kirk Defense in the Ectair system.

O'Flaherty explains that he needs to make some more repairs before the trader can make a sustained trip, and he figures that he can pick up the parts he needs and complete repairs well before the Machine arrives in the Ectair system. (Moreover, he sees a chance to turn a few fast credits by carrying rich evacuees from the planet. But O'Flaherty plans to turn an even bigger profit with the help of a piece of cargo that no one aboard the *Fife* knows about just yet.)



DOOMSDAY MINUS THREE

The two ships easily outrace the Machine to Ectair. If the player characters request it, the science staff can estimate the time before the Machine reaches the planet. It will arrive in the Ectair system about a day behind the *Fife*, but if it behaves according to normal programming, it will linger at the fringe of the system to carve up and consume three outer worlds in its path. By the time the *Fife* orbits Ectair, the estimate places the planet's probable destruction 72 hours away. Only three days remain before the machine devours the planet and all its inhabitants.

Though it lies within Federation-controlled space, Ectair is an independent star system with only thin ties to the UFP. The planet is a major center for trade in the region, populated by Federation citizens as well as several races. Ectair also has trade agreements with the Romulan Star Empire, whose merchant ships from the Outback make frequent visits. Due to its stubborn independence and touchy pride, Ectair is a constant source of irritation to Federation authorities.

Upon establishing orbit around Ectair, the Captain must decide whether or not to inform the local government of the Machine's imminent arrival. Evacuating Federation citizens or attempting to stop the Machine would certainly require the local government's cooperation, but announcing the crisis could just as likely cause a panic. This decision must be carefully weighed.

From orbit, it is evident that Ectair is in serious trouble. Federation relief forces cannot arrive at this lonely outpost of civilization for at least six days, and though there are many ships of all descriptions on Ectair, there are nowhere near enough to evacuate the entire population. The *Fife* might be able to round up sufficient shipping to get the Federation citizens out (and the Captain's first duty is to defend these citizens), but Ectair's government would never cooperate. To force the issue would trigger a major diplomatic incident.

Of course, 72 hours from now the planet may not be in a position to protest. Nevertheless, abandoning a 'friendly' world to the Doomsday Machine would create a scandal all over the Federation and beyond. The Captain who takes such a coward's way out would probably trigger enough mass protests and outright rebellions to make the Genesis controversy look like a quiet Sunday picnic. Court martial, dismissal from Federation service, and a lifetime of recriminations is the mildest fate the Captain and his senior officers could expect.

To make matters worse, a Romulan merchant ship is in port. The Commander of this ship, a reserve officer in the Star Empire's navy, will no doubt criticize and debate every step the Federation takes. All in all, the Captain soon realizes that evacuation of Federation citizens is not a viable option.

The Captain had better decide on a course of action quickly. Because the Machine pursues a straight-line course to the nearest star system after each attack, projections show that it will turn toward the heart of the Federation once it finishes with Ectair. Though it might be easier to defeat the Machine there, the cost in lives would be enormous.

THE CAPTAIN'S CHOICES

The Captain of the *Fife* has three choices before him. Although the players may do whatever they want, almost anything they do come up with is likely to fall into one of these categories. (If particularly clever groups invent unusual solutions not listed here, the gamemaster will have to wing it on his own.) The Captain's three possible choices lead in different directions. Refer to the flow chart in the **Gamemaster's Notes** for guidelines on how to proceed with the adventure from here.

The most obvious course of action is for the *Fife* to come to the aid of Ectair. That means approaching the government or finding some other way to secure a ship that can be used for the Kirk Defense, the only known way to a Doomsday Machine. This course of action is a good step, but the Captain will have to deal with Ectair's touchy and (understandably) panic-stricken government.

A second course of action involves some loss of face, but makes it more likely that the Ectairians will cooperate. If the Romulans already at Ectair knew of the crisis, they could use their greater influence with Ectair's government to gain their support more readily. Romulan cooperation, however, may carry a high price, and could be difficult to maintain, due to conflicting motives.

The third choice would be to do nothing. This decision might come about if the players take a 'wait-and-see' approach to matters. It might also arise if the players choose to abandon Ectair entirely (in which case the adventure is over, and the player characters are relieved of duty, charged with negligence, and court-martialed). Finally, they might find themselves surrendering the initiative simply through indecision. Too much time spent analyzing and debating possible actions will carry a heavy penalty.



TO ECTAIR'S AID

The Captain must take quick and efficient action, both to protect Federation citizens on Ectair and to score a few diplomatic points by rescuing the planet from certain disaster. If he carries this out in the name of the Federation alone, the diplomatic triumph would be particularly strong. It might even strengthen Ectair's ties to the Federation, shifting their heavy reliance on trade with the Romulans. Many considerations point to this choice as the most correct.

Files on the Doomsday Machine suggest that the Kirk Defense is the only sure way to defeat the Machine. It requires a matter-antimatter explosion inside the mouth of the device, using a Federation cruiser's engines. Unfortunately, it also requires the use of a spare starship. At present, there are only three ships in the Ectair system capable of attempting the feat: the *Fife*, the Romulan *Deletham Mosarum*, and the *Cosmos Royale*, a large Ectairian liner. For the Kirk Defense to work, Captain Culver must gain the use of the *Cosmos Royale*.

The Captain can pursue one of three routes to obtain the Ectairian liner. One way is to approach the government officially. Although the liner is owned by the Kinglines Corporation, the planetary constitution does allow ships to be mobilized for the planet's defense in times of emergency. A second route is to appeal to the corporation directly, though it is possible the owners of the liner may be too greedy to sacrifice the ship. Another possibility is to use the *Fife's* marines to seize the liner. Although a highly illegal move, it could probably be justified if the operation is a success. The player characters could also enlist Romulan aid, but it would mean giving up some of the advantages to be gained from working alone. More than one route may have to be explored before achieving success. It is also possible that the efforts to gain the *Cosmos Royale* will fail utterly.

DIPLOMATIC APPROACH

If the Captain chooses to approach Ectair's government concerning the *Cosmos Royale*, he must deal with Amehda Mozinphar, the Master of Ectair. That poses some problems because Mozinphar is an unscrupulous, selfish, rather weak-willed leader totally under the thumb of Ectair's mercantile interests. The bottom line in the matter is that Kinglines will want to use the ship to evacuate their key people, and Mozinphar has a place reserved for himself. Thus, he is rather hesitant to turn the ship over to the Federation.

It will take 1D10 hours to arrange a meeting with Ectair's Master. If the Captain balks at the delay, he can make a Skill Roll against his rating in *Negotiation/Diplomacy* to hasten the process. The Captain may attempt four rolls in a given hour. Each successful roll subtracts one hour from the delay (a result of 0 means an immediate meeting can be arranged). A failed roll adds 1D10 hours to the original time. The gamemaster should role play these interactions using Mozinphar's Special Assistant, Shrenos. When rolls fail, this urbane, polite Assistant will suavely announce that "matters of state have detained his Excellency, and he asks that I reset his meeting with you gentlemen for a more convenient time", or words to that effect.

The player characters can try to force the issue by beaming down without permission to confront Mozinphar in his office. If they do so, they will make him angry, thus jeopardizing the negotiations. They will also find him negotiating with some Kinglines people for his passage, however, and this will help their negotiating position if they are smart enough to use it. [NOTE: If the gamemaster needs guidance in setting the tone of this part of the adventure, consider the mood set by the negotiations with the Council in the *STAR TREK* episode "The Mark of Gideon".]

When the actual meeting does occur, the player characters would only be aware of Mozinphar's plan to escape the planet if they broke in on him. Otherwise, they will have no hint of his plans or intentions. Again, the gamemaster should role play the discussions that take place, but actual results will come from the following system. Average the *Negotiation/Diplomacy* skills of the character handling the negotiations with Mozinphar. This gives the Target needed to convince Ectair's leader to requisition the *Royale* for Federation use.

If Mozinphar is angry at the intrusion, halve the averaged skill rating. Should the character making the approach be Romulan, double that character's Skill Rating before calculating the average. This represents the weight carried by the local Romulan mercantile interests. The gamemaster may also modify the target to reflect the role playing between the player character and Ectair's Master. For example, Mozinphar will be more agreeable if he is guaranteed passage off-planet in case the Machine is not destroyed. He may also be more willing to listen to arguments pointing out that he is choosing between a chance to keep his position (if he sanctions using the liner for the Kirk Defense) and the certainty of voluntary exile as a wealthy but powerless refugee. Mozinphar will react negatively, on the other hand, to anyone who tries to persuade him of his 'duty' or 'responsibility', or who tries to push him around. The modifiers should be small, but they are left up to the gamemaster to set, based on how the discussion unfolds.

The player characters may have only one meeting with Mozinphar. Once his decision is made, Ectair's Master will refuse any further discussion. If the negotiations are successful, he will order the *Royale* turned over to the Federation officers to use as they see fit. They may still encounter resistance from the Kinglines people, but at least anything Captain Culver orders will have official sanction. Should Mozinphar refuse to hand over the liner, the player characters can still try to approach the ship's owners, or they can take matters into their own hands. The only way to change Mozinphar's mind is to recruit Romulan aid.

KINGLINES' GAMBIT

If the characters choose to approach the owners of the *Cosmos Royale* directly, they will have to deal with Burton King, the majority stockholder and president of Kinglines. The company is not a large concern, owning only the one ship. That one ship, however, is a particularly large, fast, and luxurious vessel. King is reluctant to give up the vessel, both because it represents his company's single largest asset, and because it is his ticket out of danger if the Doomsday Machine approaches Ectair. Unlike Mozinphar, King will not hesitate to make this clear to the characters. As a businessman, he intends first and foremost to protect his investment.

The player characters will have an easier time reaching King, who agrees to a meeting with them in 1D10-4 hours (a result of zero or less means an immediate meeting). He

cannot be persuaded to see the group sooner, but neither will he arbitrarily postpone the meeting time once it is set. Again, the group could beam down sooner and interrupt King, but this risks angering him and jeopardizing the success of any negotiations.

King is deaf to arguments based on patriotism, honor, saving lives, and the like, and so there is no need to roll dice to determine his response in these cases (though the gamemaster may have the players roll anyway, disregarding their results). The only kind of deal that will sway King is one involving compensation for his loss. To negotiate with him, the player characters must accept an agreement obligating the Federation to pay Kinglines the value of the *Royale* and guaranteeing King and his personal entourage (including crew and passengers now on board the liner) safe passage out of danger.

If the player characters offer King the above compensations, average the *Negotiation/Diplomacy* Skill Ratings of King and the character making the deal. The result is the chance of concluding the deal. Add 10 to the average for each increment of the ship's actual 825.67 megacredit replacement cost guaranteed in the agreement. Bargaining should be role played, but the gamemaster should start with a reasonable asking price. As offers and counteroffers are exchanged, King will begin to decrease his asking price by 1D10 percent each time, but the actual cost of the liner is his rock-bottom price. A roll against *Negotiation/Diplomacy* is made at the time King reaches his minimum (in which case it is unmodified), or when the characters agree with the price demanded, whichever comes first.

[GAMEMASTER'S NOTE: If the player characters think money is not important to Star Fleet, have the Captain make a Skill Roll against his rating in *Federation Law* to learn that his future is riding on the kind of agreement he reaches with King. The Federation will agree to compensate Kinglines at fair value, but will not like being taken to the cleaners. Although they must honor the Captain's bargain, his career as a Star Fleet officer will be adversely affected by a bad deal.

[At the end of the adventure, if the *Cosmos Royale* was purchased from King, the Captain should make a Saving Roll against his *Luc* score, subtracting 20 per multiple of the ship's value paid from the Target. If he fails, the Captain can expect to be passed over for promotion several times, and to spend a long time in the Replacement Pool waiting for a new assignment. Moreover, he can expect to draw the really rotten assignments (patrol duty in deep space, supply runs to Tantalus prison colony, or missions to investigate the weakened fabric of space near the Tholian territory) until he manages to redeem himself by capturing a working Romulan cloaking device or bringing home a Treaty of Perpetual Alliance with the Gorns. In an ongoing campaign situation, this could be a source of continuing adventures for some time to come.]

Unlike Mozinphar, King is always willing to discuss a deal, even if the offer was turned down once before. However, the offer the player characters refused becomes the new minimum that he will consider, and 1D10 hours will elapse between one meeting and the next (King will immediately meet with the group if they offer his original asking price at any time). Once King does agree to a price, he will place the *Cosmos Royale* at the group's disposal, so that they can immediately put the liner to work.

THE LAST REFUGE

It has been said that "violence is the last refuge of the incompetent". However, the Captain of a Federation frigate backed up by 250 marines is going to be sorely tempted to flex his muscles when faced by a befuddled bureaucrat, a grasping businessman, and a clock ticking down toward Doomsday. It is certainly possible for the *Fife's* Captain to seize the *Cosmos Royale* by force, save the planet, and make his apologies later.

The *Cosmos Royale* is in orbit around Ectair, and will not leave until the Machine is estimated to be six hours away. Although the liner possesses a token beam weapon and light deflector shields, a scan reveals that its shields are down and its weapons are not energized. The *Fife* can beam over a boarding party any time the player characters desire, or they can call upon the vessel to surrender (backed up by a shot across the bow) before sending the marines across. In either case, there will be no coherent resistance, though there may be a certain amount of confusion and a few incidental problems on board before the operation can proceed.

As action of this kind is not sanctioned by the Federation, it might seriously harm the Captain's future with Star Fleet. However, Star Fleet is remarkably tolerant of irregular behavior when it leads to success (as any student of Captain Kirk's career knows). If the Captain is able to use the *Royale* to destroy the Doomsday Machine, the worst he might suffer is a mild reprimand in his file. Star Fleet would probably just ignore protests from King and the Ectairian government.

Failure of the operation (the pointless sacrifice of the *Cosmos Royale*) would inevitably lead to professional disaster. The Captain could face anything from a Board of Inquiry up to a full court-martial, and could expect to lose his command, or even possibly be dismissed from the service. The Federation would lose whatever good will they still had on Ectair, unless the *Fife's* subsequent actions were particularly dramatic.

One of the senior officers is bound to be aware of how serious are the ramifications of seizing the liner. Have the players roll against their characters' ratings in *Federation Law* to learn of the above consequences. If no one makes the roll, inform the First Officer of these possibilities anyway. The gamemaster should relate the arguments in a balanced way, even though he knows that the deck is stacked against success using the *Royale* and the Kirk Defense. The players do not know how chancy the whole operation really is, but it is the Captain's duty to consider the possibility of failure before blatantly taking hostile action against a theoretically friendly power.

THE ROMULAN OPTION

The player characters may decide to enlist the help of the Romulans in their quest to stop the Doomsday Machine. Though listed as a merchant vessel, the *Deletham Mosarum* (*Wind Defender*), is an armed Romulan warship converted to civilian use. Early in the negotiations, the Romulan Commander will make it clear that his crew is on reserve status with the Star Empire's armed forces, subject to recall at need. In the absence of a higher authority, and with a threat to a sovereign planetary system with treaty ties to the Star Empire, the Romulan Captain considers himself reactivated until relieved by a higher Imperial officer. This gives the

Romulans an official status equal to that of the *Fife's* crew as military personnel. Because Ectair is considerably more friendly toward the Romulans than toward the UFP, the Captain of the *Deletham Mosarum* has a decided advantage in all his local dealings.

In the early stages of the crisis, the Romulan Captain Avolus sends out a coded message to a squadron of Romulan vessels exploring in the Outback region, asking for advice from the squadron Commander. If the *Fife's* Communications Officer makes a Skill Roll against his rating in *Starship Sensors*, the player characters learn of this transmission when it is made (as soon as they or Patrick O'Flaherty release news of the Machine). The message is indecipherable, but the fact that the Romulans are making a call is significant.

Captain Avolus will not object to making common cause with the Federation unless ordered otherwise by his distant superior. The Romulans have records and intelligence reports that discuss the Doomsday Machine and the mechanics of the Kirk Defense, but their information is far from complete. Avolus hesitates to try the defense on his own, but it is also his duty to protect Ectair and to bring glory to the Star Empire. One way or another, he will eventually take action, although he would prefer to use Federation know-how if he can.

As a result, Avolus will be fairly cordial if approached with the suggestion that the two powers cooperate to save Ectair. He will not take kindly to the suggestion that his ship be used to destroy the Doomsday Machine, however. (His response is to offer his ship's hospitality to the Star Fleet crew once they have used the *Fife* to destroy the Machine. He will also be glad to use his influence in persuading the Ectairian government to give up the *Cosmos Royale*.)

[GAMEMASTER'S NOTE: All aspects of the negotiations with Avolus should be role played, with no die rolls used. If the players are sensible enough to extend an olive branch to the Romulans in the face of the crisis, the dice should not diminish their success. Avolus will not do anything contrary to Romulan interests, and he would automatically reject any offer that is obviously silly and improper. The gamemaster will find the information in FASA's *The Romulans* supplement of great help in his portrayal of Avolus.]

If Avolus is with them, the player characters can approach the government a second time. Further, the chance of success is significantly higher if the Romulan does the negotiating. As his price for cooperating with the player characters, Avolus insists on an equal share of glory in all activities related to stopping the Machine, and complete computer records on the Doomsday Machine.

The intervention of Avolus, particularly if it comes after the *Fife* contingent has failed to sway the Master of Ectair on their own, is a blow to Federation prestige, but not a serious one. If Avolus is brought in right from the start, the Captain should make a Saving Roll against his luc score at the end of the game to avoid having Star Fleet express displeasure at his handling of the matter (which probably would result in another dreary patrol mission for the *Fife*). If Avolus is brought in later, subtract 40 from the Target before making the roll. Obviously, it is best if the Captain never has to bring in Avolus at all, but losing face may be preferable to the consequences of complete failure.



ABOARD THE FLOATING CRAP GAME

Obtaining the *Cosmos Royale*, nicknamed "the floating crap game" because of its reputation as a gambler's paradise, is essential if the player characters plan to use the Kirk Defense. The method used to gain access to the ship will determine how quickly they can modify it for a showdown with the Doomsday Machine.

If the liner is taken by force, total chaos will prevail on board, and the marines will have to restore order. At the same time (or shortly thereafter), player characters should be taking charge of the vessel and handling the complaints their actions have triggered.

It will take 2D10 hours for the marines to round up, secure, and beam down the crew and passengers of the *Cosmos Royale* to Ectair. Until that time has passed, any player character or group of player characters on the ship must make three rolls per hour for possible encounters (see *Cosmos Royale Encounters* in the *Gamemaster's Notes*). While the encounters are more often nuisances than threats, they are still troublesome to the player characters who have more important things to do than deal with panicky civilians.

It will take several hours to automate the liner so that a skeleton crew can maneuver it against the Doomsday Machine. In order to set up the automation and destruct systems for the Kirk Defense, several different skills must come into play. Each hour, a crewman can make one Skill Roll; if successful, the system is ready for use.

Computer Technology is used to rig the automation systems and allow one to ten men to handle the ship under almost any circumstances. *Electronics Technology* and *Warp Drive Technology* must be used to rig the ship for detonation. *Starship Helm Operation* and *Astrogation* are used to tie the automation circuits into the ship's controls. *Astronautics* is used to hook together all shipboard systems. Each of these rolls must be made before the Kirk Defense can be undertaken.

In addition, extra Skill Rolls against a character's rating in *Warp Drive Technology* (again, once per hour at most) can be made to improve the chances of producing a suitable blast to take out the Machine.

One player character or NPC can work on one project at a time. Extra characters might also work on the same project, but they will be under one officer's supervision, and only his skill rating counts. Modifying the shipboard systems can begin as soon as Captain Whittaker turns over the computer access codes that permit the ship to function. The player characters will encounter Whittaker either as a result of the *Cosmos Royale Encounters* or automatically at the end of the marine roundup.

The job will be less chaotic if the government has turned the ship over to the Federation. In this case, Burton King will demand to see the Captain before the players' group boards the ship. He will attempt to bargain for guaranteed passage and reimbursement in the same manner as discussed in *The Kinglines' Gambit*. However, if the characters are operating with official Ectairian sanction, the Federation is not obliged to do anything for King.

Otherwise, there is not much change in the course of events. The marines must still restore order, but it takes only 1D10-4 hours (at least one) to finish up, and there are

only two encounter rolls made per group of characters per hour. All the requirements for rigging the ship remain the same. Captain Whittaker must still be found.

If King made the agreement to turn over the ship, then there is no difficulty or delay in getting the ship. King's people disembark in an orderly manner, taking only one hour, and Whittaker simply turns over the computer codes. There are no encounters and no need to send in the marines. Rigging the ship, however, requires the same steps.

RENDEZVOUS WITH DESTINY

Eventually, the liner will be ready for space. It can get underway with a crew of at least 30, or if the automation center is rigged and there is at least one man on the bridge to take her out. Work can continue on board even after the ship has moved out of orbit, but the vessel cannot use warp drive if the detonation system has already been rigged or if the player characters wish to rig the system in transit.

At this moment, the Doomsday Machine is busy digesting one of the outer planets, and is only four hours away at impulse power. The *Fife* (and the *Deletham Mosarum*, if the Romulans are working with the player characters) will have to accompany the *Royale* so that its transporters can receive the liner's crew as the trap is sprung. If the Romulans are involved, they will insist upon having an equal number of their crew share the danger with the Federation personnel. Thus, the crew of the *Cosmos Royale* will be evenly divided between both.

As the starships near their rendezvous with destiny, subspace interference begins to break up their communications, with intermittent signal bursts drowning some channels entirely. The interference shifts randomly from channel to channel, and each attempt to communicate requires the Communications Officer to make a Skill Roll against his rating in *Communications Systems Operation* to get through. Erratic waves of energy similar to an ion storm rock the vessels, while sensors detect high radiation levels and traces of anti-protons. Receiving sensor reports of fantastically powerful energy held inside a neutronium sheath, the computer raises the deflector shields. Then, blocking out the stars, the massive, cylindrical bulk of the Doomsday Machine appears on the screen.

The task of placing the *Royale* directly in the path of the behemoth requires that the Helmsman make a Skill Roll against his rating in *Starship Helm Operation*. It is important that neither ship open fire or move under power directly toward the Machine. To do so will provoke an anti-proton beam attack that will pierce the liner's light shields with hardly a pause. When the *Fife* encountered it earlier, the Machine was weak with almost nonexistent energy reserves. Now, it is fully-powered from ingesting nearby worlds, and capable of destroying anything its computer sees as a threat, however minor.

As soon as the *Cosmos Royale* drifts to within 3000 kilometers (one hex, if using the *STAR TREK III Starship Combat Role Playing Game*) of the Machine's maw, a tractor beam will seize the helpless liner. Once the tractor beam begins to draw the ship to its doom, the crew has 6 minutes and 47 seconds to set the time-delay detonator and get off the giant bomb.

Once the countdown begins, the gamemaster should roll percentile dice and consult the Doomsday Encounter Table in the *Gamemaster's Notes* to determine what happens next. The encounter must be resolved, and the *Royale's* crewmembers beamed to safety before the time limit runs out. Keep in mind that only one transporterful of crew can be beamed out at a time. Crewmembers needed aboard the *Cosmos Royale* include a Helmsman (until the tractor beam takes over), a Navigator (ditto), an engineer to oversee the destruct mechanism (who can leave any time before the end), and possibly a communications technician. Any others are optional. One character is needed to trigger the destruct system and start the countdown, but any of the above personnel could handle the job.

After everyone is beamed over from the *Royale*, the *Fife* withdraws to a safe distance, to watch as the liner is drawn into the mouth of the Machine. First, there is a blinding burst of light. After the burst dies out, however, the glow inside the Machine's maw is undimmed, and the behemoth continues to lumber on toward its goal. The experts have been proven correct. Admirable though it is, the Kirk Defense is not infallible.

Ectair's only hope is gone.

INITIATIVE LOST

It is possible that the player characters will, for one reason or another, forfeit the initiative in dealing with the Doomsday Machine. They might deliberately choose not to act, adopting a "wait and see" attitude, or they might decide to abandon Ectair entirely. It is also possible that delays, either through indecision or through the slow workings of bureaucracy, will give the Romulans time to advance plans of their own.

Every hour that passes before the liner is turned over to (or seized by) the Federation makes Romulan intervention more likely. Starting from the time the Romulans learn of the Machine, roll 1D10 at the end of every hour and keep a running total of the rolls. When the number rises above 75, the Romulans act. Die rolls are not made if the liner is in Federation hands or if the Romulans have agreed to work with the *Fife's* crew.

Should the Romulans seize the initiative, they will ask for and receive the *Cosmos Royale*. Using what they do know of the Kirk Defense, the Romulans will attempt to destroy the Machine. The *Fife* will sit by, a useless spectator, as the attempt is made and fails.

The stage is set for doomsday on Ectair.

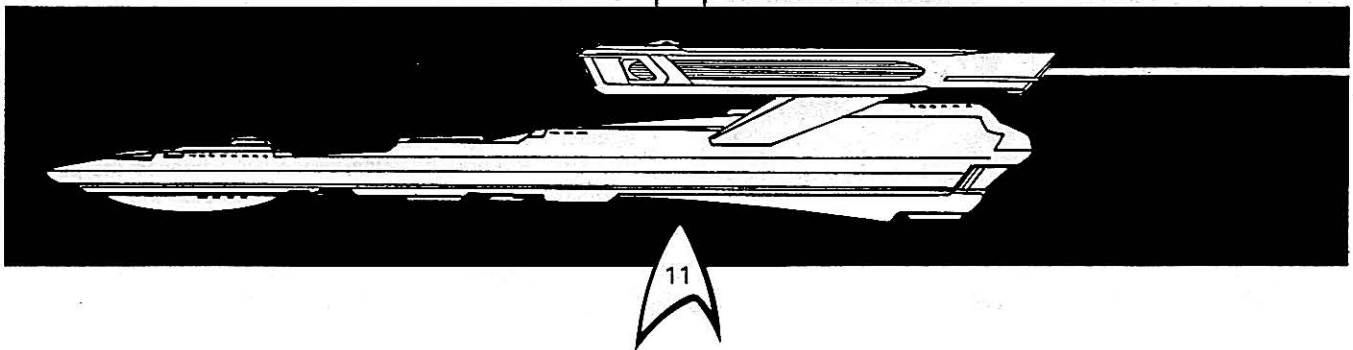

SECOND CHANCE

After the Kirk Defense fails to destroy the Doomsday Machine, the second part of the adventure begins. Returning to Ectair, the *Fife's* crew is desperate to find some alternative to Doomsday. The player characters will get a second chance, but it is a dangerous one. Events during this stage of the adventure are tightly controlled, and do not require a flow chart to regulate them.

ENTER O'FLAHERTY

At the very beginning of the adventure, trader Captain Pat O'Flaherty faced the Doomsday Machine. Although there were contradictions in his story of an accidental encounter with the Machine, he was too pressed for time to discuss the matter when the Machine was so close. It is likely that the players will have shelved the matter (perhaps even forgotten it), but those inconsistencies do point the way to the solution of the crisis. The players' group should realize this for themselves, and decide to look into it. This process might even begin while the Kirk Defense is being set up (O'Flaherty's secret might be discovered in time to prevent the loss of the *Cosmos Royale* entirely), but it is presented here for the sake of convenience.

If the players' group does not track down O'Flaherty and discover the information covered below in **Beacon of Hope**, then O'Flaherty himself will come forward after the Kirk Defense fails.

When he gets in touch with the *Fife*, the Irish Captain seems hesitant and nervous, not at all like his cheery self. He insists on talking to the *Fife's* Captain.

"Well, now, looks like you boyos didn't do so well that time around, eh Captain," he says brashly enough. "I, er, I think I might have stumbled onto something that can help. Leastways, I think you can use it." He refuses to elaborate by radio, and invites the Captain and senior officers to come aboard the *Pride O'Rigel* for further discussion.

When they beam over, the player characters may be startled to see Avolus and three of his officers already comfortably seated in the lounge, whether or not they had previously notified the Romulans.



BEACON OF HOPE

O'Flaherty has an embarrassing confession to make. "We weren't meanin' no harm when we went to explore that thing out there," he says defensively as the meeting gets underway. "'Twas dead as a Klingon's enemy when we sighted it, and we were thinkin' salvage'd net us a pretty credit or two — the sensors said it was pure neutronium! We didn't really know what t'make o' the big thing, so we decided t'check out the little pod thing we spotted orbiting the big one."

The Irishman goes on to explain that the small pod, made of the same neutronium armor, but giving off faint power readings, was orbiting the Machine at a range of just under 100 kilometers. The *Pride* closed with the pod, and O'Flaherty and some of his men donned suits to check it out. As they materialized near the object, however, an energy beam, like a phaser but much more powerful, blazed out of one end of the small pod. O'Flaherty fired a hand phaser at the weapon end, which on later examination proved to be a non-neutronium assembly, and disintegrated the metal. It turned out that the energy beam had damaged one of the *Pride's* engines.

After this, O'Flaherty and his men maneuvered the pod into the cargo bay of the freighter, but not without incident. As they got it inside, the traders noticed that another metal section had been depressed into the neutronium shell, and was now glowing with a soft, cold light. They noticed too that the mouth of the Machine was also glowing, and sensors showed a small buildup of power inside. Within minutes, the Machine was on the move.

O'Flaherty assumed the Machine was chasing his ship because he had disturbed it, but he did not think they could afford the time to jettison the new cargo. They ran, calling for help, until the damaged engine was about to give way. At that point, the *Fife* showed up and saved the trader, making jettison of the pod unnecessary.

The rogue trader does not know the nature of the gadget he discovered. However, as he puts it, "You military types might know what t'do with it...leastways, more than me boyos can puzzle out."

O'Flaherty shows them the pod, a cone-shaped structure three meters long and over a meter across at the base, mostly covered by a thin plating of neutronium armor. Certain sections, however, are composed of an unknown, translucent metal alloy. One of these sections is glowing brightly, and tricorders will pick up an energy source in the heart of this very small object that is roughly equivalent in power output to a very small warp drive unit.

The pod is resting on its conical base atop a small force-field generator. O'Flaherty points out that this is because the base of the pod, like the open end of the Doomsday Machine, is evidently designed to draw in matter to fuel a conversion furnace. "I don't know 'bout you lads," he says, "but I've no great wish to have me or me cargo sucked in t'power that little bugger." He makes no move to turn the pod over to anyone, despite anything the player characters might ask him. "Just be patient, me lads, and we'll get down t'business soon enough."

Back in the lounge, with drinks all around for his guests, O'Flaherty starts talking again. It is a true pity, he tells them, that the Machine was activated and turned loose against Ectair (neglecting to mention that it was probably his fault). It would be even worse if it smashed the planet. Although the Kirk Defense has failed to stop the behemoth, perhaps the pod will offer some kind of alternative.

In studying the artifact, O'Flaherty's people have come to the conclusion that it is a kind of beacon, perhaps a way of signalling, or even of controlling, the Machine. If so, the pod might be able to stop the Machine before it can destroy Ectair. Unspoken but implied in O'Flaherty's sales pitch is the suggestion that the pod offers control of the most awesome weapon ever seen in this galaxy.

"As I see it, me boyos," the Irishman concludes, "Ye each have a stake in this. But o'course it's been me own risk and expense t'make all this possible. Sure, and I'm just a poor, hardworkin' businessman, an' this is costin' me money. So I have t'recoup me losses somehow... and I'm willin' t'hear yer bids."

A NEW PROBLEM

Captains Culver and Avolus suddenly receive communicator calls at this juncture. Responding, the Captain is given startling news by the officers commanding the *Fife* in his absence. Six Romulan warships have just decloaked and entered orbit around Ectair. They have taken no other action, but their presence changes the situation radically.

Avolus, after a brief communicator conversation, turns to the Captain. "By now, Captain, I'm sure you know what has happened. I am required to make a report to my Commander. Perhaps we can resume this...auction...at a later date." His tone conveys a soldier's disgust for O'Flaherty's tactics and intentions. Moments later, Avolus beams back to his ship, without speaking to O'Flaherty at all.

After this interruption, O'Flaherty makes it clear that he will not discuss anything further until he has a chance to see both parties at once. "Can't go makin' deals 'til I know all me options, boyos," he says, grinning. Then, after a moment, he adds a warning. The force field generator under the pod is not only designed to keep the pod from damaging the ship, but it also contains a powerful self-destruct system that can be used to destroy the artifact if the need arises. "None o' yer bully boys, Cap'n. Try somethin' unfriendly and ye'll have no more choices left at all, laddie."

Back aboard the *Fife*, the Captain can get more information on the Romulan squadron. Only one of the ships, a *V-6 Gallant Wing Class XII* cruiser, is a match for the *Fife*. The rest of the squadron is made up of three *V-5 Skyfire Class VII* cruisers and two *V-9 Night Flyer Class VI* cruisers. Each vessel is capable of both military and research tasks, and together, this squadron is a dangerous foe for a single ship like the *Fife* to face. In any dispute that might now arise, the Federation is decidedly outclassed.

For almost an hour, the Romulans ignore calls to their ships. Then, abruptly, the *V-6* (obviously the flagship of the squadron) puts a call through to the *Fife*. The Romulan Commander, a veteran officer named Tal, wishes to meet with the Captain of the *Fife*.

The Romulan begins by pointing out the provisions of the Treaty of Ectair. His ships have every right to be here, having been called away from exploration duty by Avolus and his story of the Doomsday Machine. Tal also mentions the provision of the treaty in which the UFP and the Star Empire jointly pledge to protect Ectair from aggression. This, Tal suggests, is the time to honor that pledge.

Tal has learned from Avolus of O'Flaherty's artifact and his intention to sell it to the highest bidder. He has received a similar warning from the Irishman about the self-destruct

mechanism, and is unwilling to attempt to seize the device. On the other hand, he does not wish to play along with O'Flaherty's auction. As Tal sees it, his duty is to defend Ectair from the Doomsday Machine, using the pod to help achieve this. He also feels that Federation information on Doomsday Machines and Star Fleet's superior scientific faculties could be crucial in solving the riddle of the pod.

"We can waste time and effort bidding against each other," Tal says. "We could also squabble over this prize while the *talas latta* comes closer. Or we could work together against the Carrier of Death, this Doomsday Machine, as you call it. I prefer the latter alternative, but I am prepared to take whatever action is necessary. What is your desire, Captain?"

The Romulan Commander's terms are quite straightforward. They will approach O'Flaherty together and persuade him to yield up the pod without getting involved in protracted negotiations. After that, Tal proposes that Romulan and Star Fleet personnel work together to discover the pod's secrets and to stop the Doomsday Machine. If need be, the squadron can undertake a Kirk Defense of its own, but Tal does not plan to destroy his own ships unless absolutely no other alternative exists.

THE DOOMSDAY BARGAIN

Captain Culver has little choice in this situation. To provoke a confrontation would violate Star Fleet orders (and probably be suicidal as well). Balanced against this is the need to prevent Doomsday technology from falling into Romulan hands. The resources of the Romulan squadron could easily make the difference between success and failure in any attempt to stop the Machine. It is very likely that the player characters will ally with the Romulans.

Should the Captain refuse Tal's offer, the Romulans will act on their own. They order O'Flaherty to surrender the pod or be destroyed, and will use the same threat against the *Fife* if the player characters attempt to interfere in any way. The *Fife*, then, becomes a helpless onlooker as the Romulans do their own research, discover the pod's secrets, and board the Machine. Thereafter, when the Romulans gain control of the Machine, the *Fife* will have to fight her way through the Romulan squadron to try and self-destruct inside the Machine's maw so that the advanced military technology is denied to the Star Empire. Such an attempt has little chance for success. Alternatively, if the pod is destroyed, the player characters will watch the Romulans attempt to deactivate the Machine with plasma weapons and exploding ships until they are either successful or there are no ships left to try. That will leave the *Fife* as the only bastion against the Machine.

If the player characters agree to the Romulan offer, both parties will have to deal with O'Flaherty. Tal is in favor of using threats as a negotiating tool, but presumably the player characters themselves will not condone this approach as long as anything else is possible. As noted before, it is quite possible that O'Flaherty will give in if it is clear he cannot save his ship any other way. If threatened, the Irishman will point out that, despite his ship's Orion registry, he is still a Federation citizen. He also will noisily protest being threatened by the people charged with protecting him, and this will be grounds for Star Fleet censure of the Captain later.

Dealing with O'Flaherty requires that a player make a Skill Roll against his character's rating in *Negotiation/Diplomacy*. Also needed is a successful Skill Roll against a character's rating in *Federation Law* to find appropriate statutes dealing with the requisition of material necessary for Federation security. Because O'Flaherty is a Federation citizen, he is subject to such a law. This alternative should be explored only if one of the characters comes to question the legality of O'Flaherty's blackmail.

The other way the group can negotiate is to meet the Irishman's price. He has yet to admit what he wants, but his story holds a clue. O'Flaherty hoped to salvage the inert Doomsday Machine, but would not acquire anything of value without a way to manipulate neutronium. A promise of salvage rights to the deactivated Machine is his real price. If such a deal is made, the Federation could always buy the rights back after O'Flaherty realizes that he is not really capable of handling the job. (Actually, he is hoping to be bought out later. He knows that a warship Commander is unlikely to dicker over prices, but bureaucrats and scientists, who will step in after the crisis is over, will certainly do so.) To realize that this is the Irishman's price, players must either think of it on their own or make a Saving Roll against their characters' *INT* score to have the gamemaster supply the hint.

Of course, player characters may be concerned with the possible reaction of their Romulan allies. Commander Tal, however, will agree to the suggestion without hesitation. A properly wary player may realize that this is a clue to dangers to come.

If such a bargain with O'Flaherty is made, he will want to be involved in everything that follows. The Irishman will even volunteer his ship to aid in the investigation. Tal reacts favorably to the offer. The *Pride* is a good platform for experimentation and research: it keeps the pod on neutral ground, and does not tie up any of the combat-capable ships that might be needed. One way or another, the player characters will be strongly encouraged to use the *Pride O'Rigel* for the next stage of the adventure.



SECRET OF THE BEACON

Once a bargain is finally struck, Avolus and his crew are appointed as liaison to the *Fife*, and researchers can go to work on the pod. Any single character delegated to be in charge of the investigation can begin making two Skill Rolls per hour against his rating in *Starship Sensors* to begin learning about the device. The gamemaster should present the physical data on the beacon pod (*see Gamemaster's Notes*) when the roll succeeds.

There are seven basic systems within the device that may be selected for closer scrutiny. These are: communications, electronics, weaponry, computer, tractor beam, power plant, and propulsion. Only one system can be examined at a time. To learn more about the system, a player must make two Skill Rolls per hour against the skills listed below.

The communications system is examined using *Communications Systems Technology*. If the roll is successful, this system proves to be hooked into three pressure plate switches set around the middle of the cone (including the glowing, depressed panel). There are also links to the pod's simple computer, and to an antenna array set for a specific subspace band, one on which static from the Machine has never been recorded.

The electronics system (*Electronics Technology*) yields an internal circuitry diagram that shows a close connection between the computer, communications, and weaponry systems. If the character also possesses a rating in *Communications Systems Technology*, he may make a Saving Roll against his *INT* score to draw parallels between this system and an early model Andorian IFF transponder from the era of the Romulan War.

The weaponry system (*Starship Weaponry Technology*) is no longer functional, but is tied to both computer and communications systems and seems to have been triggered by a metal-detector. Evidently, it was programmed to fire at the largest target within a given volume of space (estimates place the range at one kilometer unless overridden by a communications code).

The computer system (*Computer Technology*) is fairly simple. It controls all functions of the pod, and is closely linked with the communications and weaponry systems. The three pressure plates that ring the cone (including the one that is depressed) seem to hook into both the communications system and directly into the computer.

A character may attempt a second roll against his rating in *Computer Technology* to learn more. If successful, the character learns that the three panels are part of a fail-safe system. When all three are depressed in a certain order (the order cannot be determined by analysis), the communications system is fully activated. If they are pressed in the wrong order, the computer will overload the power plant, destroying the pod and everything within 50 kilometers. When a single panel is pressed (as one is now), the communications system transmits a brief signal of some kind. Evidently, three pulses in the correct order place the pod in full communication with something else. (Allow the players to roll against their characters' *INT* scores to realize that one pulse activates a quiescent Doomsday Machine, while three wrong pulses activate the device and destroy the pod. Three right pulses must somehow control or communicate with the active Machine.) The second skill roll also teaches the characters how to deactivate an active pressure panel.

The propulsion system (*Shuttlecraft Systems Technology*) is an extremely compact type of impulse engine of rather low power. Some interesting concepts for miniaturization are available here, but no real insights into pod operation.

The tractor beam system (*Physics*) mounted on the narrow end of the cone and tied into the communications system is evidently activated by the transponder mechanism. It works on a completely unfamiliar and indecipherable principle.

The power plant (*Warp Drive Technology*) defies analysis. No matter what the skill roll, no information is yielded. The player characters may not realize that they are wasting their time, however, and could study it fruitlessly for hours before they realize it is a dead end.

No amount of analysis will reveal just what the pod is for, but the players may be able to deduce that the pod serves as some kind of beacon, communication device, or control mechanism for the Doomsday Machine. It will take experimentation to find out just what it does.

The three pressure panels can be pressed in any of six combinations. There is no way of choosing the right pattern, and the signal pulses transmitted by the device cannot be duplicated with the equipment and computer codes currently available. On a purely random basis, then, there is a 16 percent chance of correctly guessing the sequence to follow.

The player characters may attempt additional research into the fail-safe system. Making a Skill Roll against a character's rating in *Mathematics* increases the chance by 30 percent (to 46 percent). Making a Skill Roll against a character's rating in *Computer Technology* increases it by another 30 percent. A character who sets out to activate the beacon also gets an additional 5 percent for having an *INT* score of 70 or more, and 20 percent for having a *LUC* score of 70 or more. Thus, assuming sufficient time is spent studying the problem, and a character with high *INT* and *LUC* scores activates it, there can be an automatic chance of success. (Because failure is catastrophic to all concerned, the gamemaster is advised to alter any unfavorable die rolls and make success automatic, but the players do not need to know this.) It is up to the player characters to take all the necessary precautions before trying to activate the pod. It would be wise to launch the device into space and have a volunteer do the work while everyone else keeps back by 50 kilometers or more. Once again, it should be remembered that destruction of the pod through a wrong combination would leave the players with no real alternative (barring the use of their own ship in a second Kirk Defense) for solving the problem.

DOOMSDAY INTERCEPT

Once a correct combination code is entered, the pod begins broadcasting a coded subspace radio signal. It cannot be deciphered, but shows a cyclic pattern that repeats once every 2.7 seconds. Almost immediately (at this range), the Communications Officer picks up a signal originating from the Doomsday Machine that is on the same low band of the subspace radio spectrum and matches the pattern of the pod's signal. It is clear that these two signals are not exchanging data, because they are simply repeating pulses of subspace radio energy. Anyone who makes a Skill Roll against his character's rating in *Communication System Operation* (or any player who thinks of it on his own) will be reminded of simple IFF transponder systems or recognition code signals. It is possible that the system was designed so that friendly ships, installations, or worlds can signal the Machine to ignore them. The gamemaster can use an NPC to put forward this tentative theory if none of the players grasp the significance of the pod beacon right away.

This could be Ectair's defense, but it would not be a good idea to rely on it without testing it first. (It would be embarrassing to find out that the beacon actually broadcasts alien football scores after the anti-proton beam has started to carve Ectair into manageable chunks.) The obvious course of action is to see if a ship using the beacon can enter the 3000-kilometer limit without being destroyed.

In case the experiment does not work, it is not a good idea to risk any of the starships that might still have a stab at trying another Kirk Defense. Although shuttlecraft would do, O'Flaherty has previously volunteered the *Pride O'Rigel* to make the approach. The Romulans will support him, as it fits in well with their own plans. The pod can be mounted on the trader (inside or outside, according to the players' specifications), and a mixed crew of Star Fleet and Romulans placed on board. The other ships may wish to trail behind, within transporter range, to be on hand in case of danger. Though the Romulan party will be equal to the Federation group in size, Tal will not come, even if specifically invited. Avolus, as the officer appointed as liaison to the *Fife*, will continue in command of the Romulans working with Star Fleet. He will, however, be joined by Sub-Commander S'marus, Tal's Executive Officer, plus several crack Romulan crewmen from Tal's flagship.

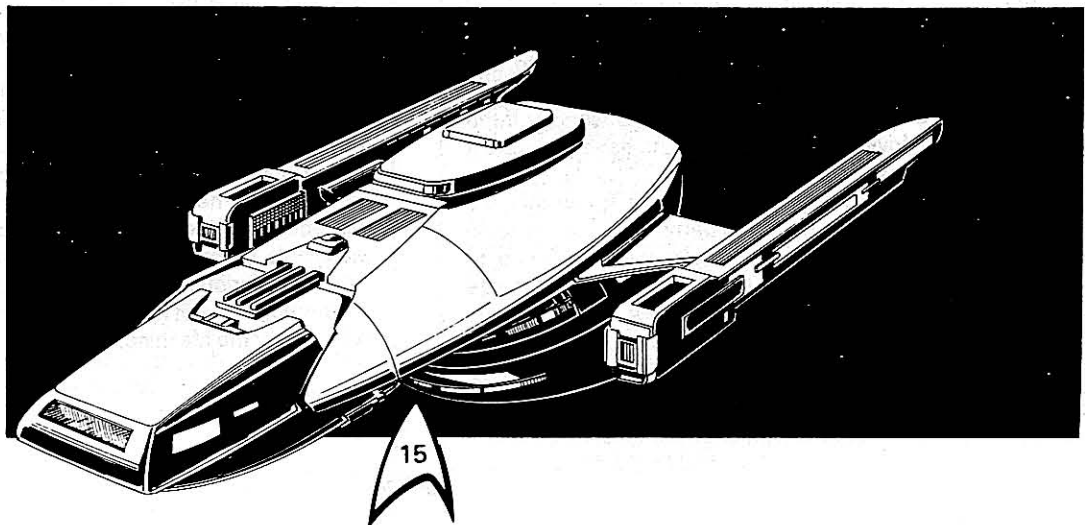

The gamemaster should play up the tension as the trader eases slowly toward the Doomsday Machine. When the ship finally passes within the 3000-kilometer limit, there is no response from the planet-killer except for the continued exchange of signals between Machine and beacon. The beacon works! As the Machine looms ahead, however, the ship lurches under the pull of a tractor beam.

Fortunately, this is not the same tractor beam that sucks matter into the maw of the Machine. Sensor readings indicate that this beam is located near the tail of the Machine, and is much weaker than the main tractor. The *Pride* could probably break free, but O'Flaherty does not want to. He is beginning to see a pattern here.

As his ship is pulled closer and closer to the Doomsday Machine, scans of its hull near the source of the beam show that there is a curiously-shaped plateau projecting from the uneven surface of the Machine. By magnifying this area, a conical depression slightly over one meter across appears. Adjacent to this is a circular bulge of neutronium that appears to be a hatch of some kind.

Within a few minutes, the tractor beam on the pod is activated. If it is inside the cargo hold, the result is very messy. Each person present in the hold at the time should make a Saving Roll against his *Luc* score to avoid being jerked across the room and onto the upper end of the pod. If the roll fails, 6D10 points of damage are taken. Other objects are also drawn toward the pod as its tractor beam swings through the hold, searching for a particular target point. If the *Pride* remains in the grip of the Machine's tractor beam for 20 seconds, the beam suddenly deactivates and the Machine takes immediate and hostile notice of the intruders. Should the *Pride* break away, the beacon shuts down until it is reactivated for a new run.

If the pod is mounted outside the *Pride's* hull, the activation of the pod's tractor beam has no ill effects. It immediately locks onto the conical opening in the Machine's hull and the trader moves toward it. The beacon pod is, in fact, not only a transponder, but also a large electronic key. When it snuggles into position in the hull, the neutronium hatch next to it swings slowly open. The Machine is inviting the party to come aboard.

ABOARD THE MACHINE

At this point, the players will probably assemble a boarding party. If they do not, the gamemaster can use Avolus or O'Flaherty to give them a push in this direction. The group will gain nothing by sitting back and staring at the open airlock.

Avolus will insist that any boarding party be composed equally of Star Fleet and Romulan personnel. If O'Flaherty has made a deal with them for salvage rights to the Machine, he will insist on having his men join the party, too. Without such a deal, the only way he can go along is if the player characters invite him. The Romulans have no interest in O'Flaherty one way or another.

If O'Flaherty is left behind, he will wait a few minutes and then organize his own boarding party of six men. Should there be Federation and Romulan personnel assigned to keep an eye on the trader, the Irishman will give a private signal to his people, who will wait for an advantageous moment, produce hidden weapons, and turn the tables on these guards. Then, he will take his men across. This event

can be played out if a player character is among the guards left behind. Otherwise, it just happens behind the scenes.

To cross over to the Doomsday Machine, the boarding parties can use either EVA techniques (in environmental suits or in life support belts), or they can transport straight to the outer hull of the Machine (still in life support gear of some kind). They cannot use transporters to gain access to the Machine because of the shielding effects of neutronium. Upon reaching the airlock door, they discover that the outer neutronium hatch has slid aside to reveal a second hatch, made of some unknown metal alloy, set just inside. This hatch is manually operated, opening inward with a turn of a circular wheel.

THE AIRLOCK

After opening the hatch, the party will find themselves inside the airlock. If the manual hatch is closed, light automatically comes on inside, and sensors read increasing pressure as an unbreathable atmosphere fills the compartment.

If the inner airlock door is opened and then closed, the atmosphere in the airlock evacuates again, and the light goes out. If the inner door is left open, the outer door cannot be opened unless energy weapons are used to burn through the hatch. This will evacuate the air within, depressurizing every connected compartment not sealed off by a closed hatch.

If the inner door is closed, it cannot be reopened from the inside until the airlock is pressurized. This is accomplished by pressing a yellow button next to the hatch. When that button is pressed, the airlock remains pressurized until the inner door has been opened and closed again.

The airlock can only hold four people at a time, and so it may take some time before all the characters can get inside. Trial and error rather than skills will be necessary to solve the airlocks mystery. Have the characters make Saving Rolls against their *Luc* scores to break off any stalemates, allowing a character to do the right thing accidentally to get the party moving again.

Actual exploration of the Doomsday Machine's interior should be performed using the map and key provided in the *Vessels* section. Allow the group to make a map as they go; this will help them keep track of where they are. Otherwise, memory will be their only guide. Role play the room explorations in detail.

THE CONTROL ROOM

Once the boarding party reaches the Control Room, they can begin examining various control panels. The *Vessels* section discusses each console, what it does, and how the characters can learn things about each. Remember that the group will have no idea which panel is which. Thus, a character with a high Skill Rating in *Mechanical Engineering*, for example, will not know on which console to use that skill. At this point, the Romulans will be content to follow the lead of the Star Fleet characters, as they are supposed to be the experts on Doomsday Machines. Once a character has discovered how a particular panel works, he must show other characters before they can operate it. Some panels will not do very much until the Machine's computer brain is deactivated. Deciphering the way the various controls work will be extremely time-consuming and will not yield more than the most rudimentary control over the Machine.

For the moment, understanding the controls is not a prime consideration. If and when the computer is shut down, however, an understanding of how the Control Room works could be essential for both sides.

THE MIND OF THE PLANET-KILLER

The boarding party's ultimate goal is deactivation of the Machine. There are two methods by which the computer can be shut down. Each one has its advantages, and each one has its hazards.

As computers go, the Doomsday Machine computer is not particularly sophisticated. It is large and intricate, but possesses none of the sentience of a Vaal or an M-5 multitronic unit. Because it is a fairly simple computer with a single function (the operation of the Machine), it will in some ways be harder to eliminate than other, more complex computer systems encountered by Star Fleet.

Unlike the M-5 or Landru computer, the Doomsday Machine's computer has no morality. Tricking it into self-destruction by playing on contradictions between moral considerations and Machine actions will not work.

The Machine's computer is not programmed to answer questions, and communicates only through readouts in an alien computer language. Attempting to make it answer an unanswerable question (the exact value of pi, for instance) is invalid, because the computer is not programmed to take notice of such a problem. Nor is it sentient enough to be confused by illogic. It follows its basic program; nothing more, nothing less. These various factors rule out any of the classic methods by which Captain Kirk has shattered computer systems across known space, and will force the players to adopt a more original solution.

The two workable methods of computer deactivation are shutdown and destruction. To shut down the computer, the system must first be understood (as explained in **Vessels** under the Computer Room description). Once characters know the basics of how the computer works, they will know what skills to use to deactivate the computer.

Four different Skill Rolls must be made in succession to shut down the computer. One attempt at all four rolls can be made every half-hour, and the rolls must be made in the order shown.

1) *Computer Technology* is used to determine the proper sequencing of entries, the systems used, and so forth.

2) *Communications Systems Operation* is used to approximate the codes employed to enter the commands.

3) *Mathematics* is used to encode the order in the base-18 numeric system of the Machine's builders. If the group can communicate with one of their own computers, this can be done automatically, and no roll is needed.

4) *Computer Operation* is used to actually initiate the sequence.

If all four rolls are achieved, the Machine's computer shuts off, and manual control can be established. It decelerates to a halt, and will remain so until ordered to do otherwise from the Control Room.

Should a single roll fail, the whole sequence must be repeated, but a character receives a +10 modifier to the target of those skill rolls he has successfully made. The first failed die roll alerts the computer to the possibility of tampering. If a second roll fails, the computer will lock out all subsequent attempts to shut it down. Go to the **Runaway Planet-Killer** section below for the events that follow. The player characters may or may not be aware of this, depending on how carefully they have examined the system.

Several characters can collaborate to deactivate the computer, each one making one or more of the required rolls. This allows skills to be pooled among several people. The Romulans and O'Flaherty's people (if present) will contribute help if asked. Otherwise, they will leave it to the Star Fleet group to do the work.

If the group prefers, they can simply destroy the computer by inflicting 500 points of damage by phasers (non-stun settings), disruptors, or explosives. However, destroying the computer in this fashion will trigger a furnace overload. Ten tactical turns later, the Doomsday Machine will explode with enough force to actually shatter its neutronium shell. All on board and any ship within 3000 kilometers will be destroyed as well.

The gamemaster should caution the players that the violent approach is not a good idea. The paranoia of monkeying with alien design principles should be enough to caution the players. If not, the Romulans (who in many ways are closest to understanding the minds of the Machine's designers) should be able to interject a warning. Close examination of the computer will confirm the outcome of destruction attempts.

If all else fails, a dedicated officer could sacrifice himself by activating the furnace overload. There is even the chance of rigging remote-controlled detonation to destroy the computer, with transporters recovering the person who set the explosion. This is the best way to stop the Machine if it runs wild.

BUYING TIME

While the player characters are analyzing the pod, exploring the Machine, and attempting to fathom its secrets, the planet-killer will be steadily closing on Ectair. The planet's defenders may have to buy time by distracting the Machine.

Commander Tal will ask the *Fife's* commanding officer to supply one or more officers to his flagship to advise on tactics, or else request that the *Fife* participate directly in these diversionary actions. The Machine will react as described in the section entitled **A Ship In Danger**. For every combat pass, the ship's Helmsman should make a Skill Roll against his rating in *Starship Helm Operation* to avoid becoming caught in the Machine's tractor beam. Although the Machine is programmed to concentrate on the nearest object, it will abandon that target for a more distant one that fires upon it. The Machine will answer attacks with an anti-proton beam, up to a limit of four shots in a single hour.

Each combat pass buys Ectair 15 minutes of survival. When the battle becomes prolonged, there will be many chances for fatal mistakes. A ship making a combat pass should roll for a Doomsday Encounter on the table in the **Gamemaster's Notes**.

If the *Fife* participates in the action directly, the commanding officer should make a Skill Roll against his rating in *Starship Combat Strategy/Tactics* during each pass. Success adds a +10 modifier to the Helmsman's Target when resolving each combat pass. If the commanding officer's roll fails, a -25 modifier is applied instead. If the *Fife* is not employed, the *Starship Combat Strategy/Tactics* roll should be made against the average of Tal's rating and the rating of the officer sent to help him coordinate the operation.

[GAMEMASTER'S NOTE: An officer sent over to the Romulan flagship will become a hostage when the Romulans attempt to seize the Machine.]

TRIPLECROSS

Once the Machine's computer is shut down, the danger to Ectair's population is over. For the crew of the *Fife*, however, the danger is only beginning.

On board the Machine, deactivation will be followed quickly by a surprise move by S'marus, the Romulan second-in-command. With a quick order, she will surround the Star Fleet characters (and any of O'Flaherty's people) with suddenly-armed Romulans. Although the players' group is valuable to her as a source of information, seizure of the Machine is her main goal. This awesome weapon would make the Star Empire invincible.

It is possible that the players will be alert enough to be expecting such a move. Their characters' training would certainly encourage some kind of quick response. Player characters who have previously announced that they are keeping an eye out for Romulan treachery (and who are not working on the computer or one of the control panels at the time of the Machine shutdown) can automatically respond to the Romulan threat. Other characters can respond by making a Skill Roll against their rating in *Small Unit Tactics*. If successful, a character may take any action desired (within usual tactical movement limits) during the same tactical turn that the Romulans make their move. Characters who fail to respond are caught by surprise and may not act until the next turn. If O'Flaherty's men are part of the boarding party, they will respond by immediately taking cover.

If a fight breaks out, resolve it using the standard combat rules. If enough characters are caught by surprise, however, even those who could respond are likely to be forced to surrender. The Romulans will round up and imprison the Star Fleet characters so that they can take control of the Machine.

At this juncture, however, O'Flaherty makes a bid of his own. His men will let the situation develop between the Romulans and the Star Fleet group, then his people will make their move, attacking suddenly from the cover of the consoles and corners. His men, ignored and despised if their presence was known at all, quickly get the drop on the Romulans (or on the Star Fleet characters, if they have the upper hand).

O'Flaherty is not intervening to save the Star Fleet characters. After discovering that the Machine can be manually controlled, O'Flaherty has made some big plans of his own. The man who tried to bargain using the beacon pod will not hesitate to open negotiations about the purchase of a weapon like the Doomsday Machine. He plans to fly the Machine to Orion space or maybe even the Triangle, where he will offer it to the highest bidder; either Romulan, Klingon, Orion, or Federation. He picks up right where S'marus left off, and orders his men to disarm the prisoners and confine them in a convenient storeroom. However, he keeps several Romulans in the control room, where he can keep a close eye on them as well as use them to show his men how the controls operate.

OUTCOMES OF THE ADVENTURE

Following are some of the possible events and outcomes of the adventure. Not all of them will occur. It is up to the gamemaster to adapt this portion of the adventure to what has gone on before and to the choices the players make along the way.

COMBAT ON THE MACHINE

The three following sections explain the options open to the players' group aboard the Doomsday Machine. No matter what the Star Fleet characters do, however, the Romulans and O'Flaherty's men will fight for control of the Machine.

Escape

Locked up in the storage compartment, the player characters may decide to attempt an escape. One of O'Flaherty's men is on guard outside the compartment, facing the door from across the corridor so he can keep an eye on it. He carries a Romulan disruptor, and it is trained on the hatch. Simply opening the door and trying to rush the guard is not a good idea.

There are, however, many other ways to lure the guard out of position. For example, a Vulcan may use his psionics to make the guard reveal the fact that spare weapons have been dumped into one of the lockers in the Ready Room.

At least some of the Romulans will be confined in the storage compartment with the player characters. Though they want to escape, too, the Romulans still plan to seize the Machine for themselves. The player characters may choose to do something to keep the Romulans out of the picture. If they do not, the Romulans will certainly do what they can to get the drop on the Star Fleet characters later.

A successful escape should lead to the section entitled **Free-For-All**.

Release

If the players do not take the initiative, the gamemaster can introduce an alternative way to get the party out of the storeroom. The Romulans in the control room manage to turn the tables on O'Flaherty, overpowering several of his men and driving the Irishman and his group out. Faced with a group of very angry Romulans, O'Flaherty will decide to take his chances with Federation justice rather than Romulan vengeance. While a few of his men hold the Romulans at bay, O'Flaherty lets the player characters go, gives back their weapons, and urges them to stop the Romulans from stealing the Machine.

The Irishman will be inclined to try bargaining for his life, extending his offer of freedom in exchange for amnesty, but he does not really have much of a bargaining position, and he will not quibble.

This section is also a lead-in to **Free-For-All**.

Free-For-All

When the adventurers escape or are released, there is a renewed battle for control of the Doomsday Machine. This time, the Star Fleet characters will have to use their skills and wits to gain the upper hand.

If the characters escape, O'Flaherty's people are still in control of the control room. In some ways, this is an advantage. These men are less skilled in combat than the Romulans, and will not be expecting trouble. However, the situation will rapidly break down into a three-way fight between the player characters, O'Flaherty's men, and the Romulans, who will use the distraction to seize weapons and join in the fray.

If O'Flaherty releases the player characters, they will only have to worry about subduing the Romulans. Of course, O'Flaherty's men may still attempt treachery, but perhaps the players will have learned their lesson and taken some steps to pull their fangs.

Combat should be resolved according to the basic rules, using the map of the Machine provided on the **Vessels** section. The gamemaster should feel free, however, to streamline some of the aspects of the conflict, particularly if he is running two sides of a three-way fight.

Each time a weapon fires and misses in the Control Room, the firing character should make a Saving Roll against his *luc* score to avoid hitting the console nearest the target character. If a console is hit, it must be repaired before any of its functions can be used again. This may prove critical in the next stage of the operation. To repair the console, average the character's ratings in *Electronics Technology* and the skill used to uncover the console's secrets to come up with a target for the skill roll. One roll may be made per half-hour.

Having secured the Machine (or possibly while the fighting is still going on), the players will discover what other events have been developing outside.

TAL'S PLOY

Tal will wait patiently aboard his flagship, making distracting attacks as needed to slow down the Machine, while the party explores the planet-killer and works to shut down its computer-brain. When the Machine ceases to act because of computer shutdown, the Romulan will make a power play outside to be coordinated with activities going on inside.

Threat of Destruction

When the Machine stops moving, the Romulan ships will close with the behemoth. Tal is expecting a communication once S'marus secures the Control Room. When no communication reaches him, he rightly concludes that his boarding party has been overpowered and blames it on the *Fife's* contingent. He immediately issues an ultimatum to the *Fife* to yield up the Machine or face an attack by all six Romulan warships.

Such a move will no doubt come as a shock for the crewmembers aboard the *Fife*. How they respond is up to the players directing activities on board. Someone may be smart enough to send the Marines to the Machine (thus helping out the officers imprisoned there). However, the *Fife* will be able to beam over only a single contingent (up to the capacity of the ship's full complement of transporters). Detecting transporter activity, the Romulans are sure to attack, forcing the *Fife* to raise her screens. It is likely that Tal will send his own security troops after the Star Fleet marine party, which will intensify the problem (especially as Tal's people can beam over at will while one or two Romulans keep the *Fife* at bay).

Tal will not destroy the *Fife*; he needs it as leverage to force the surrender of the Machine. Once the *Fife* is gone, he knows he has no hold on those inside. His Romulan conditioning has taught him that the Federation will be willing to trade a frigate for a working Doomsday Machine. Therefore, he will hesitate, unwilling to push his bluff too far or too hard. In that hesitation lies the player characters' chance to extricate themselves.

The Machine in Combat

If the player characters can secure control over the control room, and if they have learned enough to operate the controls, they have an immediate and very obvious way to even the odds against the *Fife*. If properly handled, the Machine is more than a match for the Romulan squadron.

Resolve the battle using the *STAR TREK III Starship Combat Role Playing Game*. The Machine has a constant movement factor of 1, and can turn one hexside per turn in addition to any movement undertaken. The Machine's anti-proton beam is fired the same way as the Romulan plasma torpedo, but all damage results are as shown on the table in the **Gamemaster's Notes**. One shot can be fired per turn, at any point in the turn that the players specify. The main tractor beam can draw any single target at any distance one hex toward the Machine per turn. Both weapons fire straight forward, and have a standard forward firing arc for all purposes. The Machine is invulnerable, save by the methods discussed in the **Gamemaster's Notes**.

The anti-proton beam's ammunition is limited. Give the Machine an initial energy pool of 40 points. Each shot with the anti-proton beam drains 1D10 points from this pool. Each turn in which the tractor beam is used drains a single point. No points are lost in maneuvering. If the total reaches zero, the anti-proton beam will not work, though the tractor beam and engines continue to function as before. When the energy pool has been exhausted, it rebuilds points at a rate of 1D10 divided by 2 (rounded down) points per turn, still losing 1 point per turn through tractor use. The beam cannot be reactivated until the energy pool regains 40 points, though the players will not know this.

As the battle proceeds, both the Machine and the *Fife* will get to act. When things have definitely turned against the Romulans, they are likely to seek the solution described in **The Last Act**.

RUNAWAY PLANET-KILLER

If the computer is not successfully disconnected, the Machine could run completely out of control. Should this occur, the characters are in serious trouble.

On board, the fate of the boarding party is pretty well sealed. Having detected unauthorized intruders, the computer shuts down its neutronium outer hatch, and lowers a second neutronium wall to seal off the computer brain. The boarding party can escape from the computer room before the hatch closes, but they may wish to keep some men inside to destroy the brain and set off the self-destruct sequence. There is no escape from this room after the hatch is closed.

Meanwhile, the Machine will shift into a kind of overdrive. Ship's sensors will detect a definite surge of power levels as the computer brain taps into all of the power reserves. It will fire the anti-proton beam at anything that is moving within twice its usual reaction range, and with such increased power that no amount of screening will save the target ship. The gamemaster should use the energy pool formula given in the preceding section to determine the number of shots the Machine can fire. After each shot, sensors reveal a drop in total energy output as the Machine literally tears itself apart to destroy everything in sight. Smart players will have the sense to pull away until they

learn the new reaction range, and then use shuttlecraft to exhaust the Machine's energy supply while staying at a safe distance. Tal's Romulans, faced with the wrath of this awesome weapon gone mad, will forget about their plans to double-cross the Federation and will follow the *Fife's* lead, assuming the *Fife's* Commander contacts them. Other-wise, they will die fighting, like good Romulan warriors. If the weapon has an energy reserve left after all targets have been eliminated or withdrawn, it will continue to Ectair, where it will expend its remaining energies wiping out as much of the planet as it can. There may not be complete devastation, but the planet will suffer heavily,

In this new mode, the runaway Machine cannot recharge its energy reserves. Once they are exhausted, the Doomsday Machine will self-destruct, consuming all on board and any ship within 1000 kilometers.

THE LAST ACT

Faced with the Doomsday Machine in Federation hands, Tal (or his successor, if necessary) will conclude that it is the squadron's duty to destroy the Machine if it cannot be brought back in triumph to the Star Empire. That means that the player characters will soon find themselves facing a Kirk Defense launched by the Romulans. Exhaustion of the anti-proton beam will give the Romulans their chance to die heroically.

Another alternative open to the gamemaster is to have one of the Romulans aboard the Machine (perhaps S'marus or Avolus) trick their way into the computer room with a weapon just as the action begins to heat up. Once there, he will destroy the computer, causing the Machine to self-destruct.

In the case of a runaway Doomsday Machine, it may be one of the player characters who gives his life to destroy the Machine's brain.

The gamemaster should stage things so that the Machine is destroyed before the adventure is over. Capture of an intact Doomsday Machine by either side would drastically unsettle the balance of power. (Imagine a Machine escorted by a large squadron of warships to ward off starship-bombs crashing across the Neutral Zone.) If the Machine does end the adventure intact, it will probably end up self-destructing when it is being examined later by technicians, but this is a poor way to resolve things. A good, dramatic adventure is developed by forcing the player characters to trade off goals, with the capture of the Machine being the first goal to be abandoned.

Once the Machine is destroyed, any remaining Romulans will withdraw quickly, and the Ectairian government will hastily claim that the Romulans were acting as mercenaries and privateers. This puts the Federation on very shaky legal grounds. They cannot retaliate against the Star Empire or start a war with Ectair over the hostile actions of Tal's squadron without creating negative public opinion. As the story that concludes this adventure suggests, the Federation's most likely response will be to ignore the whole incident.



BACK FROM THE BRINK

Captain's Log, Supplemental:

"Following the destruction of the planet-destroying weapon, the surviving Romulan Sub-Commander has requested a truce. As the Ectairian government has issued a statement claiming that the Romulan action was performed under Ectairian auspices and authorization as a measure to save their world, my diplomatic position is a difficult one. We cannot pressure the Romulans as long as Ectair claims them to be privateers or mercenary hirelings. That leaves us with the unenviable option of having a Federation of over 500 member worlds threaten military reprisals against a practically unarmed tradeworld, a situation that would surely be capitalized on by Romulans, Klingons, and dissidents in the Federation alike. My decision: Ectair is not worth a confrontation, and Federation diplomats can handle this bag of tribbles after the *Fife* is a long way away."

The Captain shut off the log tape and glanced at the *Fife's* First Officer. "Well, Commander? Are you happy with the way things turned out, or do you think we should have pressed the Romulans harder?"

The Exec looked away. "It doesn't seem right to let them get off without even a warning, sir," she said, sounding uncertain. "They did attack us."

"And retired with a bloody nose, Mr. Marston. I don't think they'll have reason enough to try it again. Doomsday doesn't come around all that often."

"Often enough, Captain," Engineer Albrecht commented.

Marston nodded agreement. "I still think we should have made sure those Romulans never got home. They're just waiting for a chance to declare war, and if they think we're weak ..."

The Captain shook his head. "It's attitudes like that, Commander, that lead to Doomsday Machines. I don't think any of us wants to see one of those again." He turned in his command chair to face the viewscreen forward.

"Take us out of orbit, Helmsman. Warp Factor One. Let's get back out there to our nice, quiet patrol route."

ECTAIR

WORLD LOG: ECTAIR

System Data

System Name: Mozinphar's Star System

Map Coordinates: 9.1E, 2.3S

Number Of Class M Present: 1

Planetary Data

Position In System: 4

Number Of Satellites: 0

Planetary Gravity: 1.2 G

Planetary Size

Diameter: 15,600 km

Equatorial Circumference: 48,000 km

Total Surface Area: 612,000,000 sq km

Percent Land Mass: 67 percent

Total Land Mass: 410,040,000 sq km

Planetary Conditions

Length Of Day: 21 hours

Atmospheric Density: Terrestrial

General Climate: Warm Temperate

Mineral Content

Normal Metals: 87 percent

Radioactives: 25 percent

Gemstones: 34 percent

Industrial Crystals: 22 percent

Special Minerals: 13 percent

Cultural Data

Dominant Life Form: Sentient Humanoids

Technological/

Sociopolitical Index: 899773-66

Planetary Trade Profile: EBDFFFG/A (C)

LIFE AND CIVILIZATION LOG: ECTAIR

Technological/

Sociopolitical Index: 899773-66

Technological Index

Space Science Index: 8

Physical Science Index: 9

Engineering Index: 9

Planetary Science Index: 7

Life/Medical Science Index: 7

Psionics Index: 3

Sociopolitical Index

Social Science Index: 6

Cultural Attitude Index: 6

The fourth planet of a type F star, Ectair is very much reminiscent of pre-industrial Terra. There are four main continents and various scattered island chains, but the planetary population is generally concentrated on the continent of Alnakar around the shores of the inland Sea of Samakhur. The climate in this area is subtropical to warm temperate.

PLANETARY HISTORY

The system was discovered in Stardate 1/9609 by Emerak Mozinphar, an Orion pirate Captain and slave trader forced to flee the Rigel system by the chaotic conditions that accompanied the first Federation crackdown in the area. Mozinphar and a handful of Orion ship crews discovered Ectair and settled what soon became known as "Little Orion" here in the Outback. At that time, Ectair was well beyond the limits of Federation space.

In the years that followed, there was a heavy influx of settlers, many of them black marketeers, fugitives, and other criminal types. There was also a great number of hardy pioneer types searching for a less restrictive place to live and grow. As the Federation expanded toward Ectair, Mozinphar was careful to keep the peace. Freebooters could sell their goods at Ectair, but none based themselves openly here or allowed their deeds to be connected with the planetary government. Ectair was a wide-open tradeworld with a reputation for freedom, but never became the kind of place that could provoke large-scale Federation intervention.

In Stardate 2/1705, a squadron of Romulan vessels exploring the Outback visited Ectair. Here they encountered the *USS Ardent*, a light cruiser calling at Ectair for supplies. The *Ardent's* hot-headed Captain nearly started a major incident, but Emerak Mozinphar intervened and mediated in the discussions that followed. When it became clear that the Romulans had not crossed the Neutral Zone to reach Ectair, it also became clear that a major destabilization of the Federation's whole Romulan policy was imminent. The Treaty of Ectair, signed in Stardate 2/1810, gave the Romulans free access to any non-Federation planet on the frontier, provided the Neutral Zone was not crossed and that no Romulan ship approached within five light-years of any Federation world.

Ectair continued to be an embarrassment to the Federation. It steadfastly refused to join the UFP even after it was engulfed in the last Federation expansion in 2/20 - 2/22, and it welcomed Romulan merchants, explorers, and warships into the system. These visits are permitted by the terms of the Treaty, but Federation strategic planners, notably Admiral James Kirk, have become concerned with the possibility of Ectair as a Romulan espionage center or potential military base.

The death of Emerak Mozinphar and the succession of his far less capable son to planetary leadership have led to a strong diplomatic effort by the Federation to reduce Romulan influence on Ectair. So far, it has not worked.

PLANETARY SOCIETY AND CULTURE

Ectair is inhabited by a mixed bag of races, mostly of Federation origin (some even retain Federation citizenship). Of the 1,500,000 inhabitants of the world, perhaps 50 percent are Human, with most other major Federation member races having some representation as well. About one percent of the population is of Orion ancestry. There is also a small, semipermanent enclave of Romulan traders on the planet.

Government is in the hands of a Master, who theoretically serves as spokesman for the planet's Elite class, consisting of families of the original settlers, augmented by other groups ennobled later for service to the planet. The current Master is Amehda Mozinphar, son of Emerak, and

the government is well on its way to degenerating into a hereditary tyranny. Emerak's son is largely incompetent, concerned with luxury and the trappings of power. Though at the mercy of local and Romulan-based mercantile interests, his word is law on Ectair.

Ectair's society is loosely structured. Members of the Elite class, and especially the Master of Ectair, are privileged, but there are few laws and little enforcement of those that have been decreed. It is a frontier culture, with each race and group following its own ways in the absence of a single dominant culture.

Ectair's mercantile connections with the Romulans are strong, making it one of the major sources of the Romulan ale that occasionally finds its way into the Federation. The government wishes to stay on friendly terms with the UFP, but strongly resists the idea of joining it.



VESSELS

This section contains all the ship information needed to run starship battles using the *STAR TREK III Starship Combat Role Playing Game*. It also provides complete details of various rooms on the Doomsday Machine.

CHANDLEY CLASS XI FRIGATE

The *USS Chandley*, NCC-2300, was commissioned in Stardate 2/1612. Designed to combine combat capabilities with the ability to dispatch 250 marines via transporter to a boarding or landing situation in under four minutes, the *Chandley* Class proved to be a capable and efficient Star Fleet vessel.

The Military Operations Command favors *Chandleys* as 'troubleshooter' craft, delivering both firepower and combat-capable ground forces to danger spots. They are also used in mop-up actions and for placing marines aboard enemy ships in the wake of heavy fighting.

Chandley Class frigates house marine quarters, equipment, training areas, shuttle bays, and combat transporters in the large, wing-like assembly on either side of the saucer hull. The ships have spacious accommodations to permit long-duration patrols.

Of the 184 *Chandleys* built, 63 Is, 64 IIIs, and 47 IVs remain in active service. Two Is are assigned to Training Command, and 12 Is have been converted to IIIs. Four Is and one IV have been destroyed, one I is listed as missing, one I has been scrapped, and one I was sold to the private sector.

The *Chandley* Class frigate is produced at the shipyards of Sol IV, Sol VI, and Andor at a rate of four Is, 10 IIIs, and 14 IVs per year.

The *Chandley* Class frigate *USS Fife* was named for Commodore Charles Vincent Fife, commander of a Western Alliance surface naval squadron during the Persian Gulf campaigns of the Eugenics Wars on Terra. The hull was laid down in the orbital dry dock facility on Mars (Sol IV) in Stardate 2/1810. The *Fife* took its maiden voyage in 2/1902.

CHANDLEY CLASS XI FRIGATE

Construction Data:	
Model Numbers—	MK1
Date Entering Service—	2/1612
Number Constructed—	84
Hull Data:	
Superstructure Points—	28
Damage Chart—	C
Size	
Length—	315 m
Width—	262 m
Height—	90 m
Weight—	173,300 mt
Cargo	
Cargo Units—	825 SCU
Cargo Capacity—	41,250
Equipment Data:	
Control Computer Type—	M-6
Transporters—	
standard 6 person	8
combat 20 person	8
cargo	4
Other Data:	
Crew—	363
Passengers—	10
Shuttlecraft—	12
Engines And Power Data:	
Total Power Units Available—	48
Movement Point Ratio—	3/1
Warp Engine Type—	
Number—	2
Power Units Available—	16
Stress Charts—	OVM
Maximum Safe Cruising Speed—	Warp 7
Emergency Speed—	Warp 9
Impulse Engine Type—	
Power Units Available—	FIF-2
16	
Weapons And Firing Data:	
Beam Weapon Type—	
Number—	FH-11
Firing Arcs—	6 in 3 banks
Firing Chart—	2f/p, 2f, 2f/s
Maximum Power—	Y
Damage Modifiers—	10
+3	(1 - 10)
+2	(11 - 17)
+1	(18 - 24)
Missile Weapon Type—	
Number—	FP-6
Firing Arcs—	4
Firing Chart—	2f, 2a
Power To Arm—	O
Damage—	1
	12
Shields Data:	
Deflector Shield Type—	FSO
Shield Point Ratio—	1/3
Maximum Shield Power—	16
Combat Efficiency:	
D—	131.5
WDF—	91

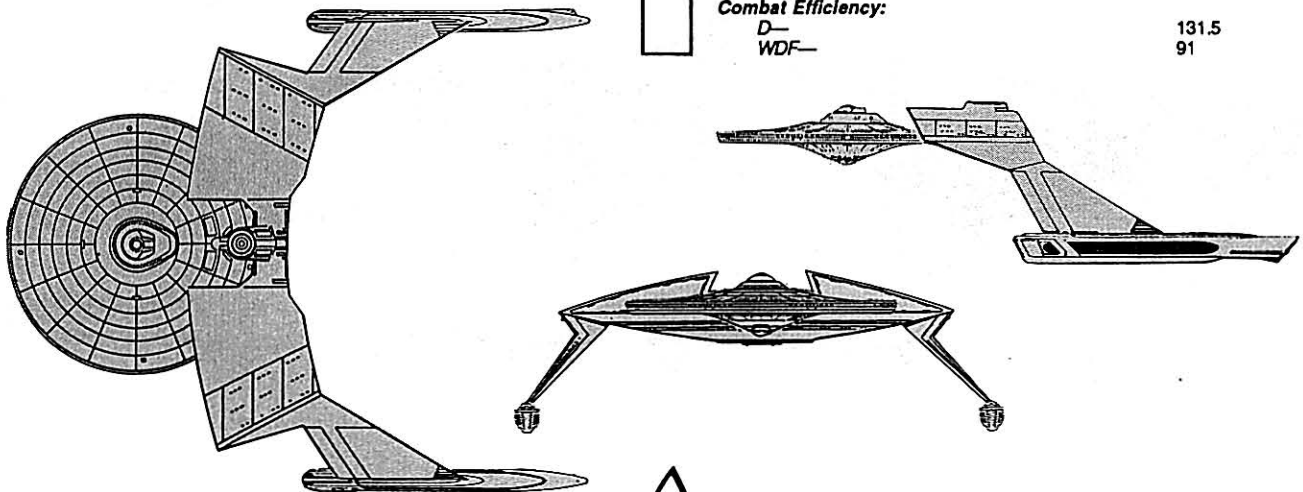

COSMOS ROYALE CLASS X LINER

The *Cosmos Royale* was the first ship in a new class of luxury liners financed by the Kinglines Corporation of Ectair, and was built at Morena shipyard facility. It was launched in 2/2112.

COSMOS ROYALE CLASS X LINER

Construction Data:

Model Numbers— MK I
 Date Entering Service— 2/2112
 Number Constructed— 1

Hull Data:

Superstructure Points— 13
 Damage Chart— C
 Size
 Length— 253 m
 Width— 135 m
 Height— 47 m
 Weight— 146,115 mt

Cargo

Cargo Units— 350 SCU
 Cargo Capacity— 17,500 mt
 Landing Capability— None

Equipment Data:

Control Computer Type— M-4
 Transporters—
 standard 6 person 4
 emergency 20 person 4
 cargo 2

Other Data:

Crew— 75
 Passengers— 220
 Shuttlecraft— 8

Engines And Power Data:

Total Power Units Available— 46
 Movement Point Ratio— 4/1
 Warp Engine Type— FWC-2
 Number— 2
 Power Units Available— 20
 Stress Charts— N/M
 Maximum Safe Cruising Speed— Warp 6
 Emergency Speed— Warp 8
 Impulse Engine Type— FIC-3
 Power Units Available— 6

Weapons And Firing Data:

Beam Weapon Type— FL-1
 Number— 1
 Firing Arcs— A
 Firing Chart— D
 Maximum Power— 2
 Damage Modifiers— None

Shields Data:

Deflector Shield Type— FSA
 Shield Point Ratio— 1/1
 Maximum Shield Power— 1

Combat Efficiency:

D— 31
 WDF— .4
 Cost: 825.67 MCr

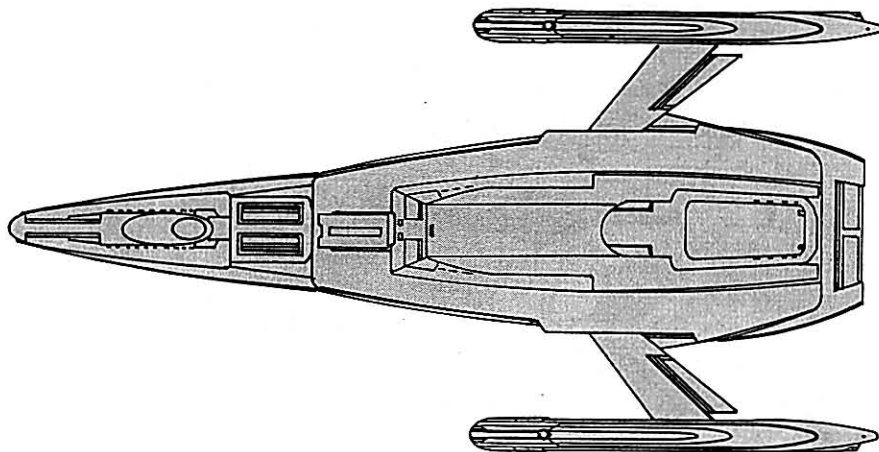
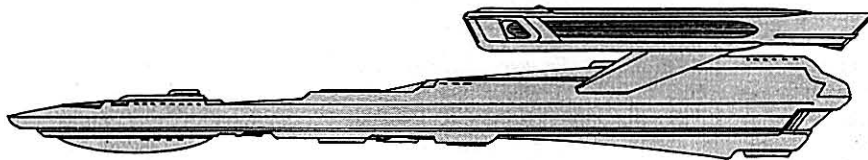

DWARFSTAR CLASS II FREIGHTER

Manufactured by Orinco Shipbuilders, a Rigellian company, the *Dwarfstar* Class of freighters is Orion in design. Small, fast, and expensive, these ships are ideal for frontier traders who need to be prepared for trouble.

The three models of Dwarfstar Class ships currently in production at the Rigel VIII shipyards are basically similar, differing primarily in armament. The Mark I design was not armed, and is primarily employed in fast courier duty and to carry small, urgent cargoes between worlds where no trouble is expected. Although popular with some Federation customers, this model never won widespread acceptance in the Orion Colonies.

DWARFSTAR CLASS III FREIGHTER

Construction Data:

Model Numbers—	MK I	MK II	MK III
Date Entering Service—	2/1005	2/1005	2/1010
Number Constructed—	215	712	310

Hull Data:

Superstructure Points—	3	3	5
Damage Chart—	C	C	C
Size			
Length—	90 m	90 m	90 m
Width—	70 m	70 m	70 m
Height—	30 m	30 m	30 m
Weight—	18,825 mt	19,005 mt	22,480 mt

Cargo

Cargo Units—	1,000 SCU	1,000 SCU	750 SCU
Cargo Capacity—	50,000 mt	50,000 mt	37,500 mt
Landing Capability—	Yes	Yes	Yes

Equipment Data:

Control Computer Type—	MK IV	MK IV	MK IV
Transporters—			
standard 6 person cargo	1	1	1
	1	1	1

Other Data:

Crew—	8	10	15
Passengers—	4	4	4
Shuttlecraft—	None	None	None

Engines And Power Data:

Total Power Units Available—	35	35	35
Movement Point Ratio—	1/1	1/1	1/1
Warp Engine Type—	OWA-2	OWA-2	OWA-2
Number—	2	2	2
Power Units Available—	17	17	17
Stress Charts—	G/F	G/F	G/F
Maximum Safe Cruising Speed—			
unloaded	Warp 8	Warp 8	Warp 8
loaded	Warp 6	Warp 6	Warp 6
Emergency Speed—			
unloaded	Warp 10	Warp 10	Warp 10
loaded	Warp 7	Warp 7	Warp 7
Impulse Engine Type—	OIB-1	OIB-1	OIB-1
Power Units Available—	1	1	1

The Mark II *Dwarfstar* is a lightly-armed model, suitable for frontier traders who need weapons on occasion, but are still more oriented to flight over fight. The Mark III is much more heavily-armed and -shielded than its counterparts. Company literature claims that the ship is intended for trade in hazardous areas, but this model is more commonly used as a raider by Orion pirate bands, and many are in service as fast corvettes or gunboats with the various Orion governments.

The *Pride O'Rigel* is a Mark II *Dwarfstar* freighter.

Weapons And Firing Data:

	MK I	MK II	MK III
Beam Weapon Type—	None	OD-2	OD-2
Number—	—	1	3
Firing Arcs—	—	a	1a, 1p/f, 1s/f
Firing Chart—	—	J	J
Maximum Power—	—	3	3
Damage Modifiers—			
+2	—	(1 - 5)	(1 - 5)
+1	—	(1 - 5)	(1 - 5)
Beam Weapon Type—	None	None	OD-5
Number—	—	—	1
Firing Arcs—	—	—	f
Firing Chart—	—	—	U
Maximum Power—	—	—	7
Damage Modifiers—			
+2	—	—	(1 - 10)
+1	—	—	(11 - 20)

Shields Data:

Deflector Shield Type—	Navigation Only	OSD-1	OSF-3
Shield Point Ratio—	—	1/1	1/3
Maximum Shield Power—	—	4	6

Combat Efficiency:

D—	57.29	57.29	57.65
WDF—	0	1.9	11.5

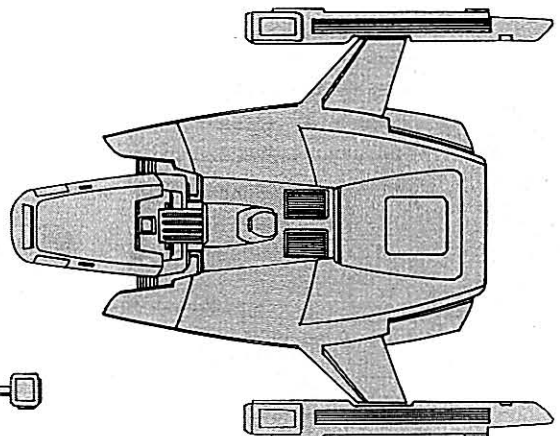
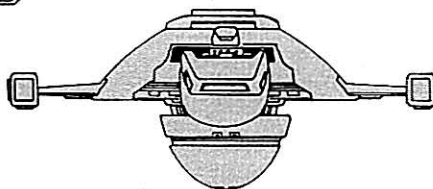
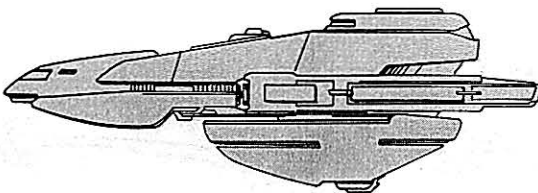

V-6 (GALLANT WING) CLASS XII CRUISER

The *Gallant Wing* (*s'ten vastam*) Class of cruisers was designed to fill both military and research duties within the Romulan Star Empire. It is roughly equivalent in size, performance, and role to the *Constitution* and *Enterprise* Class of Federation cruisers. The current line of *Gallant Wing* Class cruisers represents extensive upgrading and re-design work over the older, smaller design, nearly all of which are believed to have been converted.

The *S'ten* is Commander Tal's flagship, and is a V-6 cruiser. The Captain's rating in *Starship Combat Strategy/Tactics* is 78, and the Crew Efficiency Rating is 73.

V-6 (GALLANT WING) CLASS XII CRUISERS

Construction Data:	
Model Numbers—	Type 7
Date Entering Service—	2/16
Number Constructed—	approx. 20
Hull Data:	
Superstructure Points—	26
Damage Chart—	B
Size	
Length—	172 m
Width—	252 m
Height—	48 m
Weight—	190,000 mt
Cargo	
Cargo Units—	250 SCU
Cargo Capacity—	12,500 mt
Landing Capability—	None
Equipment Data:	
Control Computer Type—	R5M
Transporters—	
standard 9 person	4
emergency 20 person	2
cargo	2
Cloaking Device Type—	RCE
Power Requirement—	38

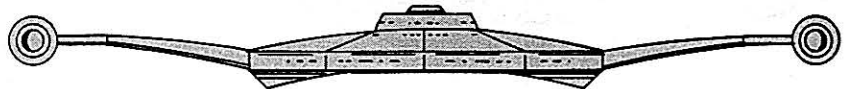
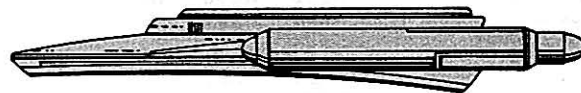
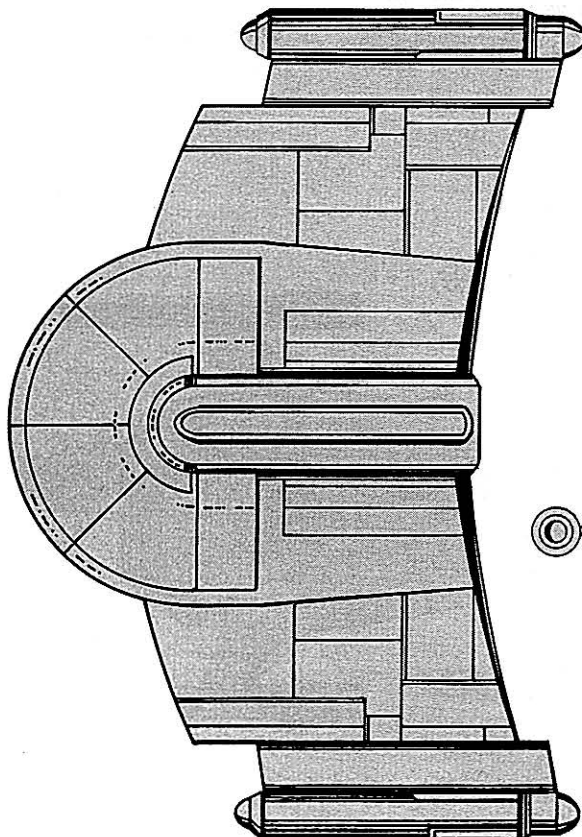

Other Data:

Crew—	300
Shuttlecraft—	4
Engines And Power Data:	
Total Power Units Available—	52
Movement Point Ratio—	4/1
Warp Engine Type—	
Number—	2
Power Units Available—	24
Stress Charts—	G/L
Maximum Safe Cruising Speed—	Warp 7
Emergency Speed—	Warp 9
Impulse Engine Type—	RID-1
Power Units Available—	4
Weapons And Firing Data:	
Beam Weapon Type—	
Number—	RB-9
Firing Arcs—	6 in 3 banks of 2
Firing Chart—	2p/f, 2f, 2f/s
Maximum Power—	W
Damage Modifiers—	6
	+3
	+2
	+1
Plasma Weapon Type—	
Number—	1
Firing Arcs—	f
Firing Chart—	m
Power To Arm—	15
Damage—	See chart in Gamemaster's Notes
Shields Data:	
Deflector Shield Type—	
Shield Point Ratio—	RSO
Maximum Shield Power—	1/3
Combat Efficiency:	
D—	113.7
WDF—	75.4

V-9 (NIGHT FLYER) CLASS VI CRUISER

Created from plans for the older V-8 *Bird of Prey* Class cruisers, these vessels mount twin plasma torpedoes and are more effective in combat than their predecessors. Reportedly, they are very common within frontline fighting units of the Star Empire's Navy. *Tremar vastaram*, the Romulan name for the class, refers to a small, nocturnal flying predator native to Remus. It was supposedly the source of various legends and myths about invisible predators from another dimension. Given Romulan tactics, the name is an appropriate one.

Two of the ships in Tal's squadron are V-9 Class cruisers. The *Hatham (Predator)* has a Captain with a *Starship Combat Strategy/Tactics* Skill Rating of 70 and a Crew Efficiency Rating of 58. The *Kalabam (Tempest)* has a Captain with a Skill Rating of 70 and a CER of 56.

V-9 (NIGHT FLYER) CLASS VI CRUISER

Construction Data:	
Model Numbers—	Type 6
Date Entering Service—	2/15
Number Constructed—	approx. 70
Hull Data:	
Superstructure Points—	16
Damage Chart—	B
Size	
Length—	136 m
Width—	190 m
Height—	57 m
Weight—	70,900 mt
Cargo	
Cargo Units—	80 SCU
Cargo Capacity—	4,000 mt
Landing Capability—	None

Equipment Data:	
Control Computer Type—	R4M
Transporters—	3
standard 9 person	2
emergency 20 person	1
cargo	1
Cloaking Device Type—	RCC
Power Requirement—	15
Other Data:	
Crew—	162
Shuttlecraft—	2
Engines And Power Data:	
Total Power Units Available—	34
Movement Point Ratio—	3/1
Warp Engine Type—	RWC-2
Number—	2
Power Units Available—	15
Stress Charts—	NQ
Maximum Safe Cruising Speed—	Warp 6
Emergency Speed—	Warp 7
Impulse Engine Type—	RC-2
Power Units Available—	4
Weapons And Firing Data:	
Beam Weapon Type—	RB-6
Number—	4 in 2 banks of 2
Firing Arcs—	2p/1s, 2a
Firing Chart—	T
Maximum Power—	6
Damage Modifiers—	
+2	(1-18)
Plasma Weapon Type—	RPL-1
Number—	2
Firing Arcs—	F
Firing Chart—	E
Power To Arm—	10
Damage—	See Chart
Shields Data:	
Deflector Shield Type—	RSH
Shield Point Ratio—	1/2
Maximum Shield Power—	11
Combat Efficiency:	
D—	70.4
WDF—	42.4

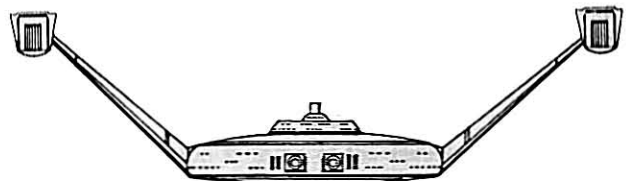
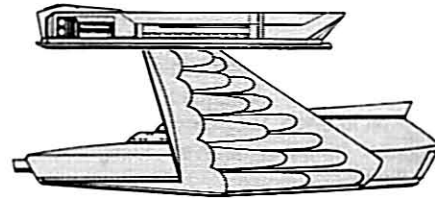
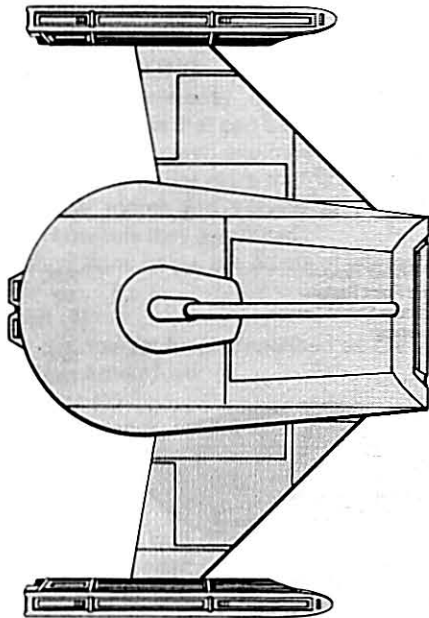

V-5 (SKYFIRE) CLASS VII CRUISER

A Romulan cruiser utilized for both military and research work, the *Skyfire* is much better in battle than as an exploratory vessel. It is believed used primarily in Romulan reserve fleets, and probably sees little frontline duty. A variant Class VIII type also exists.

Three ships of Tal's squadron are V-5 cruisers. The *Talla (Duty)* has a Captain with a *Starship Combat Strategy/Tactics* Skill Rating of 65 and a Crew Efficiency Rating of 58, the *Mandukar (Vigilant)* has a Captain with a Skill Rating of 70 and a CER of 60, and the *Deletham (Defender)* has a Captain with a Skill Rating of 70 and a CER of 68.

V-5 (SKYFIRE) CLASS VII CRUISER

Construction Data:	
Model Numbers—	Type 1
Date Entering Service—	1/96
Number Constructed—	approx. 40
Hull Data:	
Superstructure Points—	17
Damage Chart—	B
Size	
Length—	160 m
Width—	233 m
Height—	60 m
Weight—	93,500 mt
Cargo	
Cargo Units—	170 SCU
Cargo Capacity—	6500 mt
Landing Capability—	None
Equipment Data:	
Control Computer Type—	R4M
Transporters—	
standard 9 person	3
emergency 20 person	2
cargo	1
Cloaking Device Type—	RCC
Power Requirement—	15
Other Data:	
Crew—	270
Shuttlecraft—	2
Engines And Power Data:	
Total Power Units Available—	35
Movement Point Ratio—	3/1
Warp Engine Type—	RWD-1
Number—	2
Power Units Available—	16
Stress Charts—	O/O
Maximum Safe Cruising Speed—	Warp 6
Emergency Speed—	Warp 7
Impulse Engine Type—	RIB-2
Power Units Available—	3
Weapons And Firing Data:	
Beam Weapon Type—	RB-5
Number—	4
Firing Arcs—	2p/a, 2s/a
Firing Chart—	V
Maximum Power—	5
Damage Modifiers—	
+3	(1 - 10)
+2	(11 - 16)
+1	(17 - 21)
Beam Weapon Type—	RB-6
Number—	2
Firing Arcs—	f
Firing Chart—	T
Maximum Power—	6
Damage Modifiers—	
+2	(1 - 18)
Shields Data:	
Deflector Shield Type—	RSJ
Shield Point Ratio—	1/1
Maximum Shield Power—	14
Combat Efficiency:	
D—	61.3
WDF—	43.8

S-9 (WIND CARRIER) CLASS V SCOUT

This scouting vessel is, by all accounts, a popular design in the Romulan fleet. It exists in two principle variants, which differ mainly in weaponry. Additional variants have been converted from the basic Type 1 and used in the civil sector, where they make excellent small merchant ships.

Avolus' vessel, the *Deletham Mosarum*, is an S-9 scout. It will not participate in combat, as its officers are aboard the Doomsday Machine.

S-9 (WIND CARRIER) CLASS V SCOUT

Construction Data:	
Model Numbers—	Type 1 Merchant
Date Entering Service—	2/14
Number Constructed—	unknown
Hull Data:	
Superstructure Points—	7
Damage Chart—	C
Size	
Length—	72 m
Width—	120 m
Height—	20 m
Weight—	44,300 mt
Cargo	
Cargo Units—	225 SCU
Cargo Capacity—	11,250 mt
Landing Capability—	Yes
Equipment Data:	
Control Computer Type—	R3M
Transporters—	
standard 9 person	1
cargo	1
Other Data:	
Crew—	20
Shuttlecraft—	None
Engines And Power Data:	
Total Power Units Available—	23
Movement Point Ratio—	2/1
Warp Engine Type—	RWD-2
Number—	1
Power Units Available—	18
Stress Charts—	O/O
Maximum Safe Cruising Speed—	Warp 7
Emergency Speed—	Warp 8
Impulse Engine Type—	RIB-3
Power Units Available—	5
Weapons And Firing Data:	
Beam Weapon Type—	RB-7a
Number—	2
Firing Arcs—	f
Firing Chart—	M
Maximum Power—	4
Damage Modifiers—	
+3	(1 - 3)
+2	(4 - 9)
+1	(10 - 14)
Shields Data:	
Deflector Shield Type—	RSC
Shield Point Ratio—	1/2
Maximum Shield Power—	6
Combat Efficiency:	
D—	52.0
WDF—	12.0

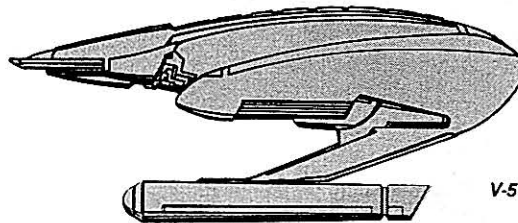

V-5 (Skyfire)

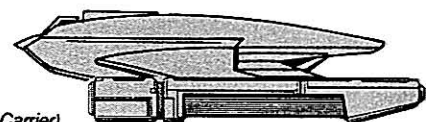

S-9 (Wind Carrier)

THE DOOMSDAY MACHINE

The following information will help the gamemaster set the atmosphere for investigations aboard the Doomsday Machine. This section also contains a map and room descriptions of the Machine.

SHIPBOARD CONDITIONS

Unless changed as a result of manipulation of the environmental controls, the conditions aboard the Machine are computer-set at the time the beacon pod locks into the hull. Lighting is dim and orange-red. The atmosphere is a corrosive fluorine compound that eats away at environmental suits (causing them to break down after 2D10 hours of exposure). Life support belts are not affected, however.

The temperature is below freezing, and gravity is maintained only if specifically called for from the environmental console. When activated, gravity is at .8 G, but another control on the same console allows any setting from .1 to 4.5 G.

Hatches are generally manually-operated and airtight. There is no provision made for locking them, and no easy way to improvise locks. They are all set to swing 'outward', that is, in the direction toward the airlock.

Communications within the Machine are possible only between rooms on the same level, or directly through one of the shafts between levels. Communicators can be left behind, if need be, to serve as relay units. It is possible to communicate with ships outside only by placing someone in the airlock to relay messages (or by placing a relay communicator there), or by discovering how the communications console on board works.

To handle the Machine in combat, it will be necessary to crew the maneuver, weapons, and tractor beam consoles manually. If the control room viewing system is activated, the ship can be handled from the Control Room. Without that viewing system, a forward observer in the airlock will be needed to coordinate ship movements and give the orders to fire.

ROOM DESCRIPTIONS

Although the Doomsday Machine itself is gigantic, there are very few areas that can be visited. The Machine is not designed to hold a crew, and indeed is not a safe place for any characters to be for more than a few hours. The following habitable rooms are service areas only, and the fittings reflect how little they are visited.

The descriptions below are points of interest aboard the Machine.

Outer Hatch (1)

This is the manual hatch described as the way into the Machine in *The Adventure*.

Airlock Interior (2)

The airlock interior, completely sheathed in neutronium, is in Zero-G. It is large enough for four people to move about in reasonable comfort.

Inner Hatch (3)

This is set in the wall opposite the outer hatch. When opened, it leads to a shaft that resembles a ladder (leading to Hatch 4) with handholds for Zero-G maneuvering. Again, the hatch is manually operated.

Ready Room Hatch (4)

This is set in the floor or the ceiling (without gravity, orientations are rather tenuous) of Room 5, and connects to Hatch 3. It is a manual hatch.

Ready Room (5)

This is a large, empty room, notable only for the two hatches (Hatch 4 and the hatch leading to the corridor) and four sliding doors set in the walls of the room.

Locker (6)

This locker contains a single environmental suit, the shape compatible with a Humanoid form, but only one-and-a-half meters long. The helmet is out of proportion with the rest of the suit, indicating an overlarge head, or, perhaps, an odd approach to suit design. The gloves are also large, and seem designed for three massive, grasping appendages surrounding six smaller, more delicate manipulators. Federation scientists (including the ship's science staff) would be very pleased to have access to this suit for research purposes.

Access Shaft (7)

This room appears to be an empty locker, but there is a manual hatch on the far side of the room. Opening this hatch leads to a short corridor ending in another hatch, which leads to another corridor, and so on. After entering several such segments, tricorder readings will show a gradual rise in radiation. This is, in fact, an access shaft leading toward the conversion furnace. Radiation passes tolerance levels even for personnel in heavy radiation suits long before the corridor's ultimate end is reached.

Locker (8)

This locker contains a suit of design similar to that described in Locker 6, but is of a different material. It is much stiffer, heavier, and bulkier. The suit is a type of heavy-radiation armor. If it could be analyzed and duplicated, the suit might revolutionize Federation personal anti-radiation protection.

Locker (9)

This locker is empty. Originally, it was used to store the personal effects of service crews when they came aboard.

Corridor (10)

This passageway, though still in Zero-G, is much wider than the shaft that connected this level with the airlock. Handholds still line the sides, permitting freedom of movement as needed.

Storeroom (11)

This is the storeroom where the characters are confined after being captured. It contains a variety of enigmatic pieces of electronic gear, none of which could be comprehended without several years of intense examination and experimentation.

Engineering Monitor Room (12)

One whole wall of this compartment is a gigantic holographic tank. Another small board with 18 raised, glowing bumps arranged in a circle around two larger bumps completes the room's furnishings. The board is a computer terminal. If the various terminals are covered by a hand, the computer will feed views from any of hundreds of on-board cameras to the holographic tank.

The computer responds only when the proper sequence is entered. First, the topmost center bump must be covered, then up to three of the outer circle in any order, then the lowermost center bump. When this sequence is performed, a random view will come on-screen. There is a five percent chance that this will be an exterior view. Touching the same sequence will always recall that view. Other views mean very little, as they merely monitor various shipboard systems.

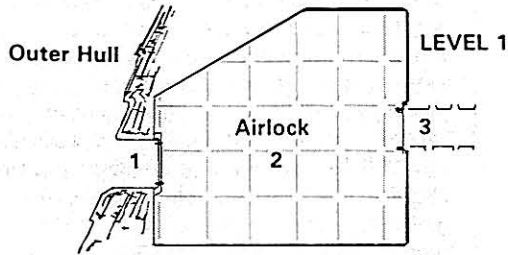

DOOMSDAY MACHINE PLANS

1 sq. = 1.5 meters

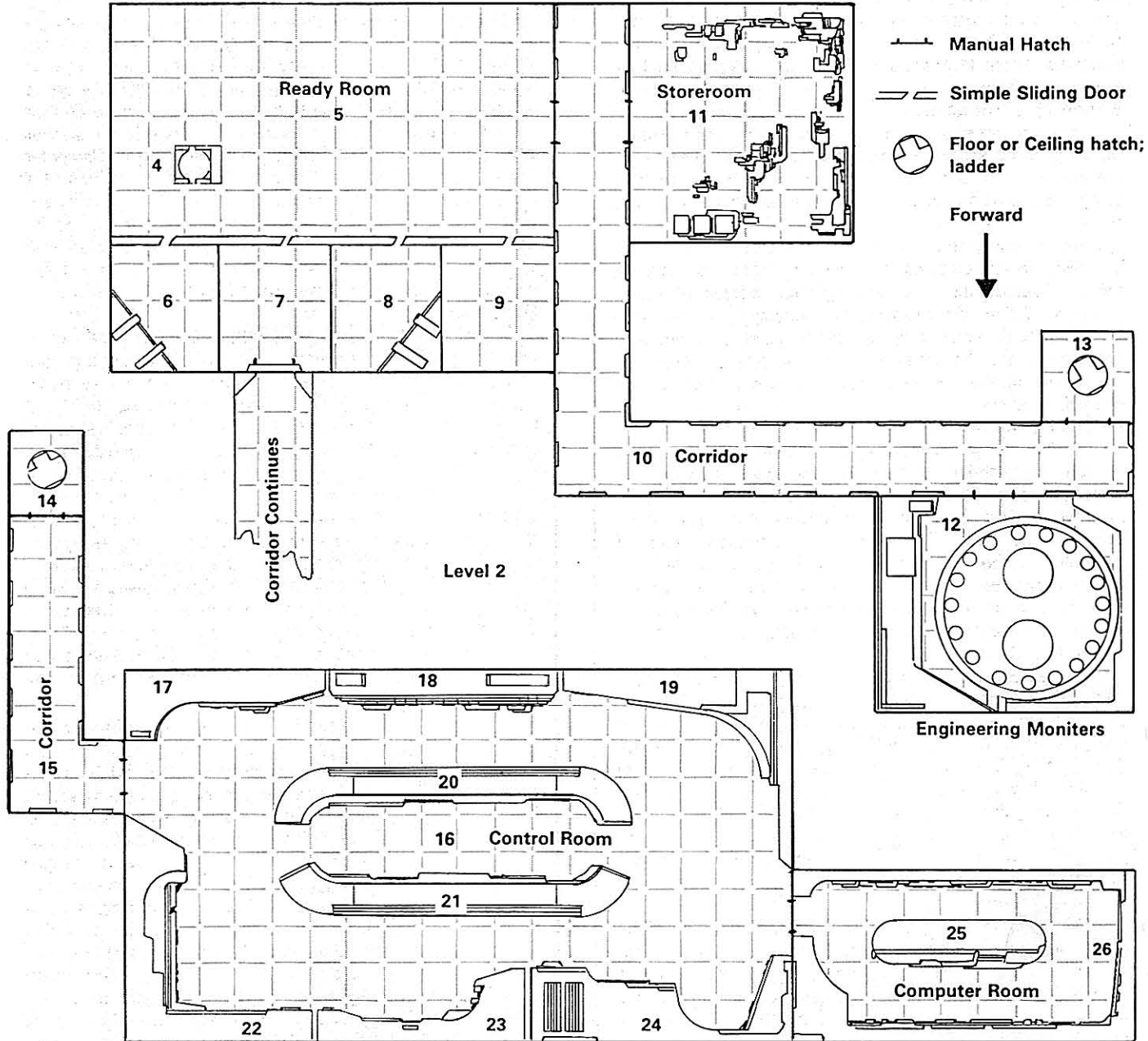

Hatch (13)

This hatch in the ceiling (assuming Hatch 4 was in the floor) opens to another shaft like the one connecting Hatch 3 to Hatch 4. This hatch leads to Hatch 14, and is otherwise identical in every way to the previous shaft.

Hatch (14)

This hatch is set in the floor of Level 3, and connects to Hatch 13.

Corridor (15)

This corridor is similar to Corridor 10.

Control Room (16)

This large chamber contains all the operational controls for the Domsday Machine. These controls are not normally used, and so these stations are merely monitors for service inspections. However, if the Machine's computer brain is disconnected, it is possible to manually control the juggernaut from here.



Environmental Controls (17)

A character who spends a half-hour studying this panel can operate it by making a Skill Roll against his rating in *Life Support Systems Technology*. Various buttons have control lights, heating and cooling systems, atmospheric pressure and recirculation, and gravity. There is a five percent chance that pushing buttons randomly will produce gravity, rather suddenly, on one of the two levels (not the airlock) at the gamemaster's discretion. There is also a five percent chance of purging the Machine's atmosphere, and a ten percent chance of changing the light from on to off, or from off to on. Anytime a random effect is produced, characters will always be able to produce that same effect again.

Engineering Monitor (18)

This is a small-scale duplicate of the system in Room 12, using a flat screen instead of a holograph. The same procedures and the same access codes operate this screen, and so it can be used to gain an exterior view of the ship's surroundings.

Furnace Monitor (19)

This monitor controls the conversion furnace. After a half-hour's study and a Skill Roll against a character's rating in *Warp Drive Technology*, a character can operate these controls, which include both a complete shutdown setting and a self-destruct setting. However, these controls only work if the computer's control of the Machine has been overridden.

Maneuver Controls (20)

A character who spends a half-hour studying this large console and makes a Skill Roll against his rating in *Starship Helm Operation* will recognize the basics of maneuvering the Machine. This console permits simple course changes only. The panel is functional only after the computer has been overridden. Random stabs at the controls (if the computer is not in control) can produce a variety of effects, such as a course change, acceleration, deceleration, or sudden activation of the transwarp drive unit.

Navigation Controls (21)

A character who spends a half-hour studying this console and who makes a Skill Roll against his rating in *Computer Operation* will discover that this panel is used to navigate the ship. However, button-pushing here must be done entirely by trial-and-error, because there are few circuits with any real corollary to familiar Federation or Star Empire navigational systems. The controls will work even when the computer is on. If it is still connected, the computer will, under no circumstances, accept external course corrections.

Weapons Monitor (22)

This console monitors and controls the operation of the anti-proton beam. A character who studies the console for a half-hour and makes a Skill Roll against his rating in *Starship Weaponry Technology* can learn how to fire the beam. Other controls here are primarily system monitors. The beam can only be fired if computer control is off.

Tractor Beam Control (23)

A character who makes a Skill Roll against his rating in *Deflector Shield Technology* after a half-hour of study will recognize controls that operate the Machine's various tractor beams. They cannot be handled manually while the computer is still connected.

Communications Console (24)

At the end of a half-hour's study, a Skill Roll against a character's rating in *Communications Systems Technology* enables him to activate the Machine's subspace

communications system. This uses antenna links buried directly in the neutronium hull to send out powerful, low-band signals. To communicate with another ship, the other vessel must be monitoring the low band used earlier by the beacon system. This should be specifically ordered or volunteered by the player characters; neither the Romulans nor O'Flaherty's men will do so unless they suggest it. Without a working system, communications must be made through relays out to the outer hull.

Computer Room (25)

This chamber contains banks of readouts and controls all around the outer walls, and a large, oval, low-set console in the center of the room. The Machine's computer systems actually occupy a great deal of additional space in the areas out of reach of the characters, but this area is the seat of the computer's brain. A character who spends a half-hour and then makes a Skill Roll against his rating in *Computer Technology* will gain a basic understanding of how the computer readouts operate, and can take a guess at the two primary methods of disarming the computer. A second half-hour spent studying just these systems, coupled with another Skill Roll, will reveal the potential pitfalls of each method of deactivation. (See *The Adventure* for details.)

Repair Monitor (26)

Ordinarily, the computer handles all repairs, but repairs can also be manually ordered (even with the computer online) from this panel. One set of controls precisely duplicates the pattern of the engineering monitor controls, and the rest of the wall contains thousands of separate color-coded bumps. Each one is a call button for specific repair robots. By punching the call button and then feeding in a three-digit location code, a robot is assigned to survey a specific site and check for damages. Robots are self-directing and do not need to be overseen to make repairs, and so there is no provision for controlling them remotely. There is a five percent chance that a randomly-summoned robot will appear near a group of characters. The codes used are the same as for the engineering monitor. Thus, any time a known code is entered, the robot will go to that site. Robot encounters are entirely harmless, but can be startling.

There is a five percent chance that a random combination of button-pushing will suddenly plunge this room into darkness, with the perfect illusion all around that the characters and the control consoles are sitting in deep space. Their surroundings can be seen perfectly, as if the Machine did not exist at all. Any ships in the near vicinity will also show up clearly, even though they may be at ranges normally beyond visibility (a result of computer processing). Another five percent chance exists of generating a holographic star map above the maneuver/navigation consoles that maps in perfect detail about 30 light years of this area of space. While this display is up, there is a 50 percent chance that pushing other buttons will produce a line leading from Ectair to another system, accompanied by glowing, floating letters beside it in an alien alphabet. Other results kill this map and replace it with another map of a completely unfamiliar region of space.

If the computer is off-line, and the local-space map with any line connecting Ectair and another star is displayed, activating the transwarp drive will make the Machine change direction and head for that star. When other maps are displayed, lines never appear, and unless the local space map is up with a course plotted, the transwarp drive carries the Machine in whatever direction it was pointed at the time of the maneuver.

CAST OF CHARACTERS

This chapter contains all the player and non-player characters necessary to run *A Doomsday Like Any Other*. Included are crewmembers from the *USS Fife* and from the *Pride O'Rigel*, the important Romulan characters, and the Ectairian natives who might be encountered at various points.

Players are permitted to use characters from ongoing campaigns or previous adventures. However, it is important that such characters have good backgrounds and attitudes established if the adventure is to be anything more than a dull exercise in rolling dice.

It is essential that the Captain, the Science Officer, and the Chief Engineer be player characters. These three have important parts to play. Least important in the overall scheme of things are the ship's Security Officer, the Medical Officer, and the Marine Commandant. Except for a few situations, these officers will not have much to do (though this was never known to stop McCoy).

Any position not filled by a player character should be filled by an NPC. The gamemaster should never allow NPCs to show much initiative. Where the players' group is small, the gamemaster may find it advisable to assign multiple characters to each player. This would be preferable to having gamemaster-controlled NPCs exercise too great an influence over the outcome of events.

CREW OF THE *USS FIFE*

The senior officers and department heads described here are for use as player characters. Players may wish to use the attributes and skills but alter names, background data, and so forth.

The characters provided as secondary officers are generally intended as NPCs. They may be called for in situations where a senior officer is not available, but an

individual with specific talents may be useful. This is particularly true in the final battle between the *Fife* and the Romulan squadron, when some characters will be on board the *Doomsday Machine*. Secondary officers might be turned over to players to run if their regular character is out of the action, whether by death, injury, or mere absence. This gives the players more opportunities to participate in the action, and removes some of the gamemaster's burden. It is also possible to expand the information given for the secondary officers so that they can be used as player characters.

Statistics on incidental officers and crewmen are given to help fill out a boarding party, contribute skills in special situations, or simply to fill in the adventure background. When such a character is needed, use the information given, making any special alterations that seem useful.

Commandant Gray of the Marine Corps Command and several marine NPCs are included to provide additional, incidental characters from among the *Fife's* marine contingent. They were generated using the character creation tables given in the *Space Marines* section in the *Gamemaster's Notes*, and are not very detailed. Because they were not created with the ordinary player character generation system, there would be some difficulty in expanding these characters, with the possible exception of Gray himself. Additional information on characters serving in this command is provided in the *Space Marines* section.

Based on rank, position, and time in grade, the chain of command aboard the *Fife* is as follows: Captain Culver (Captain), Commander Marston (First Officer), Lieutenant Commander Albrecht (Engineering), Lieutenant Commander Chiang (Science), Lieutenant Storan (Communications/Damage Control), Lieutenant Banda (Navigation), and Lieutenant Lonquist (Helm).



Jason Q. Culver

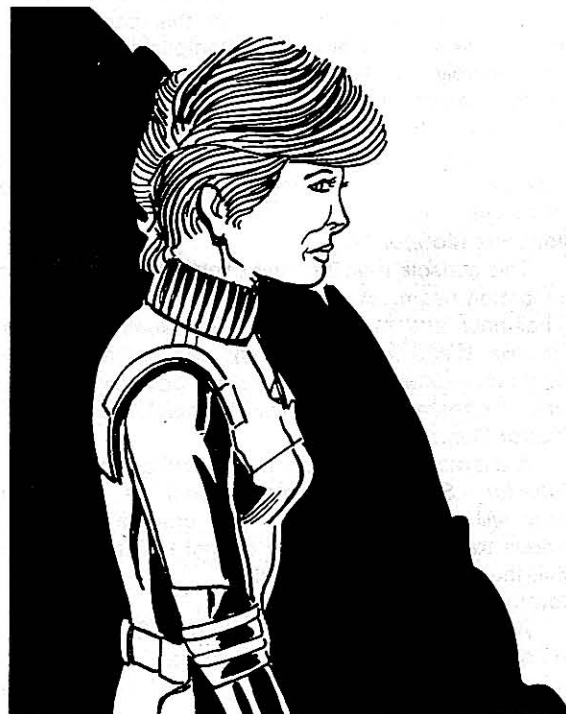

Lydia C. Marston

PLAYER CHARACTERS

Name: CULVER, Jason O.
Rank/Title: Captain
Current Assignment: Military Operations Command
USS Fife, NCC 2572
Position: Captain

Race: Human
Age: 39
Sex: Male

Attributes:

STR - 61	CHA - 83
END - 62	LUC - 82
INT - 78	PSI - 02
DEX - 63	

Combat Statistics:
To-Hit Numbers — Bare-Hand Damage: 1D10 + 7
Modern: 53 AP: 10
HTH: 54

Significant Skills	Rating
Administration	53
Carousing	26
Computer Operation	64
Damage Control Procedures	10
Environmental Suit Operation	29
Instruction	10
Language, French	22
Leadership	77
Life Sciences, Exobiology	10
Marksmanship, Modern Weapons	51
Medical Sciences	
General Medicine, Human	10
Negotiation/Diplomacy	75
Personal Combat, Unarmed	51
Personal Weapons Technology	5
Physical Science, Computer Science	10
Planetary Science, Meteorology	10
Planetary Survival, Arctic	14
Shuttlecraft Pilot	25
Small Equipment Systems Operation	18
Social Sciences	
Federation Culture/History	20
Federation Law	35
Space Sciences	
Astrogation	47
Astronautics	16
Astronomy	10
Astrophysics	10
Sports, Ice Hockey	18
Starship Combat Strategy/Tactics	76
Starship Helm Operation	59
Starship Sensors	31
Starship Weaponry Operation	65
Starship Weaponry Technology	10
Streetwise	22
Transporter Operation Procedures	10
Warp Drive Technology	10
Zero-G Operations	19

Distinguishing Physical Characteristics:
 Culver is a slender, dark-haired man who is shorter than average.

Brief Personal History:
Birthplace: McMurdo City, Victoria, Antarctica, Earth
Cadet Cruise, Military Operations Command, High Honors.
 Galaxy Exploration Command, 4 years.
 Military Operations Command, 6 years.
 Captain Culver served one year aboard the *Fife* as First Officer before his promotion, a few months ago, to command.

Personality:
Motivations/Desires/Goals:

Jason Culver is one of the few men in Star Fleet to turn down a posting to an *Enterprise* Class cruiser so that he could continue to serve in the Military Operations Command. He has an unbroken string of "Outstanding: Recommended for Promotion" endorsements on his service record, and has been compared both to James Kirk and Kelvar Garth as an exemplary Star Fleet officer. The Captain enjoys military service, and is extremely patriotic. His father died heroically in the Four Years War, and Culver is determined to live up to his reputation.

Manner:

Although he is a fine tactician and a devoted military officer, Culver is no warmonger. He believes the military's job is to prevent war when possible, fight it when necessary, and he is almost as good a diplomat as he is a soldier. Though firm in command, he is soft-spoken and cool, and leads by example rather than authority.

Special Knowledge/Powers:
 None.

Name: MARSTON, Lydia C.
Rank/Title: Commander
Current Assignment: Military Operations Command
USS Fife, NCC 2572
Position: First Officer

Race: Human
Age: 34
Sex: Female

Attributes:

STR - 61	CHA - 81
END - 65	LUC - 94
INT - 81	PSI - 41
DEX - 70	

Combat Statistics:
To-Hit Numbers — Bare-Hand Damage: 1D10 + 8
Modern: 50 AP: 11
HTH: 69

Significant Skills	Rating
Administration	58
Artistic Expression, Singing	
Computer Operation	45
Damage Control Procedures	29
Environmental Suit Operation	17
Gaming, Military Simulations	40
Instruction	19
Language, Andorian	22
Leadership	72
Life Sciences, Zoology	10
Marksmanship, Modern Weapons	47
Medical Sciences	
General Medicine, Human	10
Negotiation/Diplomacy	29
Personal Combat, Unarmed	57
Personal Weapons Technology	5
Physical Science, Mathematics	10
Planetary Science, Geology	10
Shuttlecraft Pilot	44
Small Equipment Systems Operation	29
Social Sciences	
Federation Culture/History	31
Federation Law	35
Space Sciences	
Astrogation	44
Astronautics	20
Astronomy	10
Sports, Swimming	14
Starship Combat Strategy/Tactics	75
Starship Helm Operation	74
Starship Sensors	47
Starship Weaponry Operation	65
Starship Weaponry Technology	10
Transporter Operation Procedures	10
Trivia, Military History	43
Warp Drive Technology	10
Zero-G Operations	15

Distinguishing Physical Characteristics:
 Lydia wears her blond hair in a bun, which tends to make her look like a 'schoolmarm'.

Brief Personal History:
Birthplace: Benecia Colony.
Cadet Cruise, Galaxy Exploration Command, High Honors.
 Galaxy Exploration Command, 8 years.

Commander Marston was posted to the *Fife* when Culver was promoted to Captain. All her previous tours were on board ships of either *Constitution* or *Enterprise* Class in the Galaxy Exploration Command. The transfer to Military Operation Command was made at her own request.

Personality:
Motivations/Desires/Goals:

Lydia Marston is young for her position as First Officer. A talented and extremely lucky officer, her principle ambition is to be the first woman to command a capital ship, thus breaking the unspoken discrimination against women in Star Fleet. She voluntarily shifted to the Military Operation Command to gain additional command-level experience. Had she stayed aboard *Enterprise* Class vessels, she would probably have remained a junior department officer for several more years.

Marston, like her new Captain, is a patriotic officer with a strong belief in the military and a deep interest in military history. Several of her off-duty interests reflect this, and she and Commandant Gray indulge in playing military simulation games on a regular basis.

Manner:

Marston has a strong tendency toward outspokenness. She speaks her mind, even when her opinions are unpopular. Luckily, she has always had superiors who respected candor. However, she is a very poor diplomat, and this may hold back her chances of advancement to command rank.

Marston is an efficient First Officer and a fine leader. She is extremely popular aboard ship, commanding both respect and friendship from her peers and subordinates alike.

Special Knowledge/Powers:
 None.

Name: CHIANG, Sen-Wu
Rank/Title: Lieutenant Commander
Current Assignment: Military Operations Command
USS Fife, NCC 2572
Position: Chief Science Officer

Race: Human
Age: 40
Sex: Male

Attributes:

STR - 66	CHA - 50
END - 65	LUC - 74
INT - 88	PSI - 15
DEX - 61	

Combat Statistics:
To-Hit Numbers — Bare-Hand Damage: 1D10 +5
Modern: 41 AP: 10
HTH: 41

Significant Skills	Rating
Administration	48
Artistic Expression, Vulcan Lyre	15
Computer Operation	78
Computer Technology	47
Damage Control Procedures	10
Electronics Technology	19
Environmental Suit Operation	38
Gaming, 3D Chess	26
Instruction	41
Language, Vulcan	45
Life Science, Ecology	41
Marksmanship, Modern Weapons	20
Medical Science, General Medicine, Human	10
Negotiation/Diplomacy	46
Personal Combat, Unarmed	20
Personal Weapons Technology	5
Physical Sciences	
Chemistry	24
Computer Science	60
Mathematics	76
Physics	48
Planetary Science, Geology	40
Planetary Survival, Desert	9
Small Equipment Systems Operation	10
Social Sciences	
Federation Culture/History	15
Federation Law	15
Vulcan Culture/History	10
Space Sciences	
Astrogation	10
Astronomy	64
Astrophysics	52
Starship Sensors	68
Streetwise	18
Transporter Operation Procedures	10
Trivia, Vulcan Philosophy	43
Zero-G Operations	10

Distinguishing Physical Characteristics:

Chiang Sen-Wu is a short, somewhat overweight Oriental. Due to an allergy to Retinax-5, he wears glasses to aid his weak eyes.

Brief Personal History:

Birthplace: Shanghai, China, Terra.
 Cadet Cruise, Military Operations Command.
 Cadet Cruise, Military Operations Command.
 Cadet Cruise, Military Operations Command.
 Military Operations Command, 4 years.
 Mathematics Instructor at Star Fleet Academy, 3 years.
 Military Operations Command, 7 years.

Lieutenant Commander Chiang has a remarkably poor service record. He has been aboard the *Fife* for the past three years, two of them as Chief Science Officer.

Personality:

Motivations/Desires/Goals:

A graduate from the Vulcan Institute for Science, Chiang has always wanted to go into space on a Galaxy Exploration Command research vessel. Unfortunately, in typical bureaucratic fashion, he seems to be condemned to a life in the military arm of Star Fleet.

Chiang is a great admirer of Vulcans and Vulcan philosophy. He loves intricate math problems, and it is said he related better to computers than to shipmates. Although conscientious, he abhors violence, and protests vehemently against senseless combat. A pacifist, Chiang wears sidearms only when directly ordered to do so.

Manner:

As might be expected, Chiang carries an oversized chip on his shoulder. He dislikes the military branch in general and gung-ho officers (especially Marston) in particular. He gets on well with all Vulcans, including Storan. Despite his professed admiration for all things Vulcan, however, he shows little emotional control.

Special Knowledge/Powers:

None.



Name: ALBRECHT, Helmut
Rank/Title: Lieutenant Commander
Current Assignment: Military Operations Command
USS Fife, NCC 2572
Position: Chief Engineering Officer

Race: Human
Age: 42
Sex: Male
Attributes:

STR - 82	CHA - 67
END - 72	LUC - 78
INT - 78	PSI - 01
DEX - 76	

Combat Statistics:
 To-Hit Numbers — Bare-Hand Damage: 2D10 + 2
Modern: 59 AP: 11
HTH: 48

Significant Skills	Rating
Administration	49
Artistic Expression, Photography	29
Carousing	10
Communications Systems Technology	18
Computer Operation	40
Computer Technology	16
Damage Control Procedures	10
Deflector Shield Technology	28
Electronics Technology	45
Environmental Suit Operation	27
Instruction	19
Language, Andorian	15
Leadership	30
Life Sciences, Bionics	10
Life Support Systems Technology	28
Marksmanship, Modern Weapons	36
Mechanical Engineering	72
Medical Sciences,	
General Medicine, Human	10
Personal Combat, Sword	37
Personal Combat, Unarmed	20
Personal Weapons Technology	14
Physical Sciences	
Computer Science	10
Mathematics	19
Physics	17
Planetary Science, Geology	10
Shuttlecraft Pilot	38
Shuttlecraft Systems Technology	26
Small Equipment Systems Operation	16
Small Equipment Systems Technology	29
Social Sciences	
Federation Culture/History	15
Federation Law	15
Space Sciences	
Astrogation	10
Astronautics	84
Astronomy	10
Starship Sensors	10
Starship Weaponry Technology	23
Streetwise	20
Transporter Operation Procedures	37
Transporter Systems Technology	22
Warp Drive Technology	67
Zero-G Operations	18

Distinguishing Physical Characteristics:

Albrecht is a tall, massively-built man, but surprisingly light on his feet and graceful. He has short, blond hair and a dueling scar on his left cheek.

Brief Personal History:

Birthplace: Germany, United States of Europe, Terra.
 Cadet Cruise, Colonial Operations Command, High Honors.
 Military Operations Command, 4 years.
 Astronautics Instructor at Star Fleet Academy, 4 years.
 Star Base Headquarters Command, 5 years.
 Military Operations Command, 4 years.

As an engineering officer at the Star Fleet Orbital Construction Facility at Sol III, Albrecht served under Commander Montgomery Scott in the *Enterprise* refit project. Following this, he supervised the construction of the *USS Fife* at the orbital works at Sol IV, and was appointed Chief Engineering Officer of the new ship when she was launched.

Personality:

Motivations/Desires/Goals:

Albrecht loves his ship, having been responsible for building and now maintaining her since the ship's holoprints were first drawn up. He has twice turned down prestigious Star Base appointments (with promotions) to stay with the *Fife*. His engineering skill is primarily in the generalist field of astronautics, but he involves himself in nearly everything that goes on aboard ship.

Manner:

Albrecht is crisp and efficient, a gentleman in bearing and manner. He is a very exact and precise man, not one to exaggerate his capabilities or the difficulties of a job. He has an uncanny ability to estimate repair times to within a few minutes of actual completion, even when unforeseen problems come up. His comrades do not particularly like this neat, fussy man, but they respect his abilities tremendously.

Special Knowledge/Powers:

None.



Name: QAMER, Jehan
Rank/Title: Lieutenant Commander
Current Assignment: Military Operations Command
USS File, NCC 2572
Position: Chief Medical Officer

Race: Human
Age: 41
Sex: Male

Attributes:

STR - 50	CHA - 74
END - 63	LUC - 75
INT - 82	PSI - 19
DEX - 81	

Combat Statistics:
To-Hit Numbers — Bare-Hand Damage: 1D10 + 4
Modern: 55 AP: 12
HTH: 64

Significant Skills	Rating
Administration	40
Artistic Expression, Creative Writing	39
Computer Operation	70
Damage Control Procedures	10
Environmental Suit Operation	19
Gaming, 3D Chess	10
Instruction	20
Languages	
English	15
Latin	20
Leadership	43
Life Sciences	
Botany	10
Exobiology	34
Genetics	10
Life Support Systems Technology	10
Marksmanship, Modern Weapons	28
Medical Sciences	
General Medicine, Human	80
General Medicine, Tellarite	44
General Medicine, Vulcan	41
Pathology	36
Psychology, Human	50
Psychology, Tellarite	28
Psychology, Vulcan	26
Surgery	52
Negotiation/Diplomacy	28
Personal Combat, Unarmed	46
Physical Science, Chemistry	37
Planetary Science, Hydrology	10
Small Equipment Systems Operation	29
Social Sciences	
Federation Culture/History	15
Federation Law	15
Space Sciences	
Astrogation	10
Astronomy	10
Astrophysics	10
Starship Sensors	10
Streetwise	19
Transporter Operation Procedures	10
Trivia, Moslem Theology	26
Zero-G Operations	20

Distinguishing Physical Characteristics:

Qamer is a small, slight, swarthy man with piercing black eyes.

Brief Personal History:

Birthplace: New Mecca, Palmyra III.
 Cadet Cruise, Military Operations Command, High Honors.
 Galaxy Exploration Command, 4 years.
 Merchant Marine Command, 4 years.
 Colonial Operations Command, 5 years.
 Military Operations Command, 1 year.

Following a very promising start, Jehan Qamer has had a rather disappointing career. He joined the *File* a year ago, and has been happy on board, but the previous Captain gave him low OER performance marks due to his periodic inattention to duty.

Personality:

Motivations/Desires/Goals:

Qamer has a taste for excitement that the the role of Chief Surgeon does not usually satisfy. He joined the service on the strength of the recruiting promises - to explore strange new worlds, to seek out new life and new civilizations - and has been disappointed since. Even his hitch with the Galaxy Exploration Command was lacking in the kind of action and adventure he craved.

Posted to the *File*, Qamer has tried to get involved in activities outside his own department. He volunteers for landing party regularly, and often spends his time in field work at the expense of his administrative duties. The previous Captain did not like him. Culver sympathizes with Qamer, but wishes the man would get his own work done before assisting others.

Manner:

Jehan is excitable, hot-blooded, and quick-tempered. When excited, he has a habit of spouting wild oaths in Arabic. A fairly strict Moslem, he abstains from liquor, tobacco, and other exotic substances, and spends much of his spare time writing a historical novel about the life of the Prophet.

Special Knowledge/Powers:

None.



Name: LONNQUIST, Eric J.
Rank/Title: Lieutenant
Current Assignment: Military Operations Command
USS Fife, NCC 2572
Position: Chief Helm Officer

Race: Human
Age: 29
Sex: Male

Attributes:

STR - 64	CHA - 91
END - 62	LUC - 83
INT - 73	PSI - 14
DEX - 68	

Combat Statistics:
 To-Hit Numbers — Bare-Hand Damage: 1D10 + 9
Modern: 48 AP: 10
HTH: 64

Significant Skills	Rating
Administration	40
Carousing	30
Computer Operation	53
Damage Control Procedures	10
Environmental Suit Operation	10
Instruction	10
Language, Andorian	15
Leadership	46
Life Sciences, Exobiology	10
Marksmanship, Modern Weapons	27
Medical Sciences, General Medicine, Human	10
Negotiation/Diplomacy	17
Personal Combat, Unarmed	60
Personal Weapons Technology	5
Physical Science, Mathematics	20
Planetary Science, Meteorology	10
Shuttlecraft Pilot	50
Small Equipment Systems Operation	19
Social Sciences	
Federation Culture/History	15
Federation Law	15
Space Sciences	
Astrogation	48
Astronautics	10
Astronomy	29
Starship Combat Strategy/Tactics	29
Starship Helm Operation	63
Starship Sensors	28
Starship Weaponry Operation	55
Starship Weaponry Technology	10
Streetwise	24
Transporter Operation Procedures	10
Trivia, Exploits of James T. Kirk	20

Distinguishing Physical Characteristics:
 Lonquist has longish blond hair (as long as regulations will permit, and sometimes a little longer), blue eyes, and boyishly handsome features.

Brief Personal History:
Birthplace: Republic of Mars
 Cadet Cruise, Military Operations Command, High Honors.
 Military Operations Command, 4 years.
 Lonquist has been aboard the *Fife* for just under a year.

Personality:
Motivations/Desires/Goals:
 Since he was very young, Lonquist has been fascinated by Star Fleet, and particularly by the heroic career of James T. Kirk. His two biggest ambitions have always been to serve aboard the *USS Enterprise* or to serve with Kirk in any capacity.

The recent news of the Genesis Incident, including the loss of the *Enterprise* and the threatened court-martial of Kirk, have upset Lonquist deeply.

Manner:
 Generally, Lonquist is a cheery and affable young man, popular with the ladies. Of late, he has been moody and below par in his work, which has attracted some unfavorable attention from Commander Marston. She is one of the few women on the ship who seems completely immune to his charms.

Special Knowledge/Powers:
 Lonquist knows all about Kirk's encounter with the Doomsday Machine, and is thoroughly familiar with the principles of the Kirk Defense. If the *Fife* herself was not to be risked, he would be an ideal officer for the task of coordinating the Romulan squadron.

Name: BANDA
Rank/Title: Lieutenant
Current Assignment: Military Operations Command
USS Fife, NCC 2572
Position: Chief Navigator

Race: Human
Age: 36
Sex: Male

Attributes:

STR - 80	CHA - 55
END - 82	LUC - 27
INT - 80	PSI - 22
DEX - 71	

Combat Statistics:
 To-Hit Numbers — Bare-Hand Damage: 2D10 + 5
Modern: 59 AP: 11
HTH: 62

Significant Skills	Rating
Administration	49
Artistic Expression, Painting	10
Carousing	41
Communications Systems Operation	20
Computer Operation	70
Damage Control Procedures	10
Deflector Shield Operation	66
Deflector Shield Technology	10
Electronics Technology	10
Environmental Suit Operation	10
Instruction	10
Language, French	15
Leadership	30
Life Sciences, Zoology	10
Marksmanship, Modern Weapons	46
Medical Sciences, General Medicine, Human	10
Negotiation/Diplomacy	19
Personal Combat, Unarmed	53
Personal Weapons Technology	5
Physical Science, Mathematics	40
Planetary Science, Meteorology	10
Shuttlecraft Pilot	10
Small Equipment Systems Operation	34
Social Sciences	
Federation Culture/History	15
Federation Law	15
Space Sciences	
Astrogation	77
Astronomy	47
Astrophysics	45
Sports, Gravball	36
Starship Sensors	45
Transporter Operation Procedures	10
Zero-G Operations	10

Distinguishing Physical Characteristics:
 Banda is well over two meters tall. He wears his hair short, and has rather craggy, weather-beaten features.

Brief Personal History:
Birthplace: Nairobi, United States of Africa, Terra.
 Cadet Cruise, Colonial Operations Command.
 Merchant Marine Command, 6 years.
 Star Base Headquarters Command, 1 year.
 Military Operations Command, 3 years.
 Banda has served aboard the *Fife* for 18 months as Chief Navigator.

His career has not been particularly distinguished, but Banda has a record of diligence and hard work.

Personality:
Motivations/Desires/Goals:
 Banda is unlucky; there is no other way to describe it. Still a lieutenant at age 36, he has been shunted from one dead-end post to another for most of his career. Only on the *Fife* has he begun to realize his potential.

Right now, his fondest wish is for a promotion. He has always worked hard at his assigned duties, and Banda would take almost any risk to earn the advancement he craves.

He plays as hard as he works. On leave, Banda has a reputation for drinking and barroom brawling. His shipmates claim that barkeepers from Sherman's Planet to Luna know when Banda is coming, and try to shut down before his liberty party lands.

Manner:
 Banda is serious and intense on duty, concentrating on his work to the total exclusion of the usual shipboard banter. He makes a startling contrast to Helmsman Lonquist, dark versus fair, grim versus eager, aging versus youthful and exuberant. Off-duty, Banda's manner is still intimidating to many, but he does relax and open up with a small but close circle of friends (including Lonquist and Renner, the Assistant Science Officer).

Special Knowledge/Powers:
 None.



Eric J. Lonniquist



Banda



Storan

Name: STORAN
Rank/Title: Lieutenant
Current Assignment: Military Operations Command
USS Fife, NCC 2572
Position: Chief Communications/Damage Control Officer

Race: Vulcan
Age: 35
Sex: Male

Attributes:

STR - 95	CHA - 66
END - 80	LUC - 47
INT - 87	PSI - 96
DEX - 71	

Combat Statistics:
To-Hit Numbers — Bare-Hand Damage: 2D10 + 2
Modern: 46 AP: 11
HTH: 46

Significant Skills	Rating
Administration	40
Artistic Expression	
Vulcan Lyre	10
Vulcan Poetry	20
Communications Systems Operation	77
Communications Systems Technology	46
Computer Operation	62
Computer Technology	25
Damage Control Procedures	60
Electronics Technology	18
Environmental Suit Operation	10
Gaming, 3-D Chess	24
Instruction	10
Languages,	
Andorian	29
English	30
Klingonaase	8
Romulan	32
Tellarite	28
Leadership	30
Life Science, Ecology	10
Marksanship, Modern Weapons	20
Medical Sciences, General Medicine, Vulcan	10
Negotiation/Diplomacy	43
Personal Combat, Unarmed	20
Physical Science, Computer Science	10
Planetary Science, Geology	10
Small Equipment Systems Operation	27
Social Sciences Andorian Culture/History	10
Federation Culture/History	23
Federation Law	23
Human Culture/History	15
Tellarite Culture/History	5
Space Sciences	
Astrogation	10
Astronautics	10
Astronomy	10
Starship Sensors	27
Transporter Operation Procedures	10
Zero-G Operations	10

Distinguishing Physical Characteristics:

Storan is a tall, gaunt Vulcan, a member of a minority group distinguished by light olive skin coloring (not as noticeable as a green-skinned Orion, but more swarthy than the Vulcan norm) and dark, coppery-colored hair. Storan is thus fairly unusual, even among Vulcans.

Brief Personal History:

Birthplace: Shi'rath, K'shen Province, Vulcan.
Cadet Cruise, Galaxy Exploration Command, High Honors.
Galaxy Exploration Command, 3 years.
Colonial Operations Command, 4 years.
Military Operations Command, 3 years.

Storan's father was a roving ambassador for Vulcan, and a close friend of Ambassador Sarek. Storan grew up travelling the Federation, learning about other worlds. He had a particular flair for languages and won a competitive appointment to Star Fleet Academy on the basis of this linguistic talent. He has been aboard the *Fife* since it was launched three years ago.

Personality:

Motivations/Desires/Goals:

Storan hopes to use his posting as a Star Fleet Communications Officer to improve his understanding of other cultures, and to become a diplomat like his father. Like all Vulcans, he hates violence. He fails to see the logic in his posting to the *Fife* and the Military Operations Command, but, like a good Vulcan, he continues to do his duty without complaint. His chief drive is to perfect his various skills, often volunteering for special duties.

Among the crew, Storan has particularly close bonds to the Captain (who, as the ship's Exec, once rescued Storan from rioters on a rebelling Federation client world), the Chief Engineer, and Science Officer Chiang.

Manner:

Like all Vulcans, Storan is calm, cool, and completely rational. He has learned to tolerate non-Vulcan emotions and illogic, and is a good shipmate. He finds stimulation in discussions with Chiang, but the Science Officer's passionate emotionalism often turns these discussions into debates, even when the two are in total agreement.

Special Knowledge/Powers: None.

Name: VRUNE, Gormoj
Rank/Title: Lieutenant
Current Assignment: Military Operations Command
USS Fife, NCC 2572
Position: Chief Security Officer

Race: Tellarite
Age: 33
Sex: Male

Attributes:

STR - 73	CHA - 37
END - 78	LUC - 71
INT - 76	PSI - 02
DEX - 84	

Combat Statistics:

To-Hit Numbers —	Bare-Hand Damage: 1D10 + 11
<i>Modern:</i> 81	AP: 12
<i>HTH:</i> 84	
<i>Redja:</i> 60	

Significant Skills	Rating
Administration	40
Carousing	37
Computer Operation	35
Damage Control Operations	20
Environmental Suit Operation	30
Instruction	10
Language	
Andorian	23
Vulcan	10
Leadership	48
Life Science, Zoology	
Marksmanship, Modern Weapons	78
Medical Sciences	
General Medicine, Human	7
General Medicine, Tellarite	10
Psychology, Human	9
Psychology, Tellarite	10
Negotiation/Diplomacy	10
Personal Combat, Rudja	35
Personal Combat, Unarmed	84
Personal Weapons Technology	28
Physical Science, Chemistry	10
Planetary Science, Hydrology	10
Security Procedures	70
Shuttlecraft Pilot	45
Small Equipment Systems Operation	19
Small Unit Tactics	40
Social Sciences	
Federation Culture/History	22
Federation Law	45
Space Sciences	
Astrogation	10
Astronautics	10
Astronomy	10
Starship Sensors	10
Streetwise	36
Transporter Operational Procedures	10
Zero-G Operations	28

Distinguishing Physical Characteristics:

A fairly typical Tellarite, Vrune is short and portly, with reddish hair and a porcine snout. Despite his looks, he is surprisingly fast on his feet.

Brief Personal History:

Birthplace: Kraphya Province, Tellar.
 Cadet Cruise, Military Operations Command.
 Colonial Operations Command, 2 years.
 Military Operations Command, 6 years.

Vrune has served aboard the *Fife* for nearly two years. He became Security Chief nine months ago.

Personality:

Motivations/Desires/Goals:

Vrune's current desire is for the end of the *Fife's* patrol. Three weeks ago, he received notification of his appointment as Security Chief aboard the *USS Challenger* (an *Enterprise* Class cruiser), with a raise in rank to Lieutenant Commander. He is extremely impatient to have this cruise come to a close, and he does not care who knows it.

Although the Tellarite has few friends on board, he has several enemies or near-enemies. There is a friendly rivalry between Vrune and Gray, the Marine Corps Commandant, but this sort of thing is common among the security and marine officers of frigates, and means little. Vrune has a decided dislike for Vulcans, and hates the Romulans ever since his brother, a navigator aboard a small intelligence vessel, lost his life in a skirmish with a Romulan gunboat during Operation Grey Ghost. Vrune also dislikes Lieutenant Commander Chiang intensely and is afraid of Lieutenant Banda, since the latter broke his arm in a barroom brawl. Banda is one of the few officers who can always shut up the outspoken Tellarite.

Manner:

Like all Tellarites, Vrune is outspoken and argumentative. He is so suspicious of security leaks as to be almost paranoid, a good trait in a security chief, but one the other officers find variously amusing or annoying. Vrune has a habit of being blunt and often insulting, and possesses no sense of humor whatsoever.

Special Knowledge/Powers:

The Rudja is a Tellarite weapon much like the Japanese shiruken, or throwing star. It has the range characteristics of a dagger, and does 1D10 damage. Most Rudja throwing stars carry a paralyzing or deadly poison.



SECONDARY OFFICERS

Name: WHITE, Marion
Rank/Title: Lieutenant
Current Assignment: Military Operations Command
USS Fife, NCC 2572
Position: Assistant Engineer

Race: Human
Sex: Female

Attributes:

STR - 64	CHA - 58
END - 57	LUC - 79
INT - 65	PSI - 04
DEX - 57	

Significant Skills	Rating
Communications Systems Technology	30
Deflector Shields Technology	50
Electronics Technology	24
Life Support Systems Technology	52
Space Science, Astronautics	27
Transporter Systems Technology	52
Warp Drive Technology	28

Notes:
 Lieutenant White is carrying a torch for Lieutenant Lonnquist, who is barely aware of her existence.

Name: RENNER, Thomas
Rank/Title: Lieutenant
Current Assignment: Military Operations Command
USS Fife, NCC 2572
Position: Assistant Science Officer

Race: Human
Sex: Male

Attributes:

STR - 56	CHA - 55
END - 57	LUC - 76
INT - 74	PSI - 03
DEX - 56	

Significant Skills	Rating
Computer Operation	64
Computer Technology	20
Electronics Technology	24
Environmental Suit Operation	38
Life Sciences	
Exobiology	63
Zoology	60
Physical Sciences	
Mathematics	20
Physics	23
Planetary Sciences	
Geology	50
Hydrology	48
Space Sciences	
Astronomy	29
Astrophysics	20
Starship Sensors	50

Notes:
 Renner and his superior get along poorly at best. He has applied for a transfer to Navigation.

Name: REED, Jennifer
Rank/Title: Lieutenant/MD
Current Assignment: Military Operations Command
USS Fife, NCC 2572
Position: Assistant Medical Officer

Race: Human
Sex: Female

Attributes:

STR - 58	CHA - 81
END - 61	LUC - 70
INT - 76	PSI - 15
DEX - 72	

Significant Skills	Rating
Computer Operation	52
Medical Sciences	
General Medicine, Human	83
General Medicine, Tellarite	50
Pathology	59
Psychology, Human	48
Psychology, Tellarite	47
Personal Combat, Unarmed	61

Notes:
 Reed trained for a time with the Medical Corps' Fleet Marine detachment, and has served with Commandant Gray before.

Name: VOLARA, S'vrak
Rank/Title: Lieutenant, j.g.
Current Assignment: Military Operations Command
USS Fife, NCC 2572
Position: Assistant Medical Officer

Race: Andorian
Sex: Male

Attributes:

STR - 71	CHA - 58
END - 70	LUC - 46
INT - 65	PSI - 79
DEX - 70	

Significant Skills	Rating
Starship Helm Operation	50
Starship Weaponry Operation	58
Warp Drive Technology	24

Notes:
 Volara's last assignment was aboard the *USS Reliant*. Described by his Captain as being "too militaristic" and "unable to appreciate the principles of objectivity", he was transferred out when the ship was assigned to the Genesis Project. Volara is hot-tempered and touchy about matters of honor.

Name: DONNELLY, Kevin
Rank/Title: Ensign
Current Assignment: Military Operations Command
USS Fife, NCC 2572
Position: Assistant Navigator

Race: Human
Sex: Male

Attributes:

STR - 65	CHA - 74
END - 62	LUC - 92
INT - 58	PSI - 06
DEX - 62	

Significant Skills	Rating
Deflector Shield Operation	54
Space Sciences, Astrogration	79
Starship Sensors	49

Notes:
 Despite youth and inexperience, Donnelly shows signs of promise. He is already more proficient in some major duty-related areas than his superior, Banda, who resents the young man's luck and charm.



Marion White



Jennifer Reed



Thomas Renner

Name: VORONOV, Stefan
Rank/Title: Ensign
Current Assignment: Military Operations Command
USS File, NCC 2572
Position: Assistant Communications Officer

Race: Human
Sex: Male

Attributes:

STR - 61	CHA - 73
END - 58	LUC - 76
INT - 50	PSI - 24
DEX - 60	

Significant Skills	Rating
Communications Systems Operation	42
Communications Systems Technology	11
Computer Technology	33
Damage Control Procedures	41
Language, Orion	48

Notes:
 An Admiral's son, Voronov is used to having everything his own way. Since being assigned to Lieutenant Storan, however, he has been forced to work harder than ever before, and is consequently very unhappy. Storan terms him "an inattentive pupil and an inexact officer."

Name: AUSTIN, Stuart
Rank/Title: Chief Petty Officer
Current Assignment: Military Operations Command
USS File, NCC 2572
Position: Transporter Chief

Race: Human
Sex: Male

Attributes:

STR - 59	CHA - 68
END - 62	LUC - 21
INT - 75	PSI - 04
DEX - 80	

Significant Skills	Rating
Transporter Operation Procedures	79
Transporter Systems Technology	56

Notes:
 Chief Austin is an aging, bitter man who is jealous of the rapid rise of those fortunate enough to have attended the Academy. He is superb at what he does, but routinely stays precisely within the bounds of orders (except when shipmates are in trouble).

INCIDENTAL CREWMEMBERS

Name: KUANDA, William
Rank/Title: Lieutenant, j.g.
Current Assignment: Military Operations Command
Position: Security Officer

Race: Human
Sex: Male

Attributes:

STR - 66	CHA - 62
END - 68	LUC - 42
INT - 55	PSI - 01
DEX - 63	

Significant Skills	Rating
Environmental Suit Operation	41
Marksmanship, Modern Weapons	53
Personal Combat, Unarmed	46
Security Procedures	49
Zero-G Operations	38

Name: ST. CYR, Veronica
Rank/Title: Ensign
Current Assignment: Military Operations Command
USS File, NCC 2572
Position: Security Officer

Race: Human
Sex: Female

Attributes:

STR - 85	CHA - 48
END - 73	LUC - 68
INT - 70	PSI - 01
DEX - 56	

Significant Skills	Rating
Communications Systems Technology	52
Deflector Shield Technology	49
Electronics Technology	42
Environmental Suit Operation	37
Starship Weaponry Technology	64
Zero-G Operations	44

Name: U'VREN
Rank/Title: Ensign
Current Assignment: Military Operations Command
USS File, NCC 2572
Position: Engineering Officer

Race: Caitian
Sex: Male

Attributes:

STR - 57	CHA - 60
END - 62	LUC - 66
INT - 68	PSI - 30
DEX - 89	

Significant Skills	Rating
Computer Technology	42
Environmental Suit Operation	47
Life Support Systems Technology	60
Mechanical Engineering	66
Warp Drive Technology	66
Zero-G Operations	37

Name: ZAITIDS
Rank/Title: Ensign
Current Assignment: Military Operations Command
USS File, NCC 2572
Position: Science Officer

Race: Edoan
Sex: Male

Attributes:

STR - 43	CHA - 50
END - 61	LUC - 67
INT - 61	PSI - 10
DEX - 83	

Significant Skills	Rating
Computer Operation	62
Computer Technology	31
Environmental Suit Operation	51
Starship Sensors	51
Zero-G Operations	32

MARINES

Name: GRAY, Robert L.
Rank/Title: Commander
Current Assignment: Military Operations Command
USS File, NCC 2572

Position: Commandant

Race: Human
Age: 45
Sex: Male

Attributes:

STR - 71	CHA - 66
END - 76	LUC - 71
INT - 70	PSI - 01
DEX - 80	

Combat Statistics:

To-Hit Numbers —	Bare-Hand Damage: 1D10 + 10
Modern: 75	AP: 11
HTH: 78	

Significant Skills	Rating
Administration	63
Carousing	34
Communications Systems Operations	17
Computer Operation	44
Environmental Suit Operation	40
Gaming, Military Simulations	48
Instruction	30
Language, Klingonaase	32
Leadership	77
Life Sciences, Ecology	10
Marksmanship, Modern Weapons	69
Medical Sciences, General Medicine, Human	10
Negotiation/Diplomacy	27
Personal Combat, Knife	30
Personal Combat, Unarmed	76
Personal Weapons Technology	27
Physical Science, Chemistry	10
Planetary Science, Meteorology	10
Security Procedures	53
Small Equipment Systems Operation	27
Small Unit Tactics	86
Social Sciences	
Federation Culture/History	27
Federation Law	40
Sports, Gravball	10
Streetwise	38
Trivia, Military History	40
Zero-G Operations	34

Distinguishing Physical Characteristics:

Gray is a small, slight man with iron-gray hair. He speaks with a discernible Scots accent.

Brief Personal History:

Birthplace: New Aberdeen, Inverness Colony
 Military Operations Command, 4 years.
 Marine Corps Command (garrison), 2 years.
 Military Operations Command, 7 years.
 Colonial Operations Command, 3 years.
 Military Operations Command, 3 years.

Commander Gray has served aboard the *File* for three years. He came aboard as second-in-command, but when his CO was killed in the ship's most recent ground action, Gray barely extricated his unit and won the day. He was decorated and promoted for his bravery and fine work.

Personality:

Motivations/Desires/Goals:

Gray is still unsure of himself as Commandant of the marine contingent. He fears being inadequate, deep down blaming himself for his previous CO's death. As a result, he is ultra-cautious, letting hesitation and uncertainty stifle his leadership ability.

When not concerned about his own performance, Gray is a brilliant tactician and an able military leader. He has a deep interest in military history and the ability to apply outdated lessons of warfare to modern situations.

Manner:

Gray is a good friend of First Officer Marston, who shares his interest in wargames and military history. He gets along well with the other officers, except Chiang (who dislikes what he stands for) and Security Chief Vrune, with whom he has a sort of friendly rivalry. Lately, though, Gray has been withdrawn and distant even toward his better friends.

Marston is fond of pointing out that Gray's Scottish accent seems studied, something he uses to make himself incomprehensible to his fellow officers. When he is excited or upset, she says, he is perfectly understandable.

Special Knowledge/Powers:

None.



Robert L. Gray

Name: MBANDWE
Rank/Title: Sergeant Major
Current Assignment: Military Operations Command
USS File, NCC 2572

Position: Unit Senior NCO

Race: Human
Sex: Male

Attributes:

STR - 80	CHA - 50
END - 80	LUC - 77
INT - 57	PSI - 10
DEX - 64	

Significant Skills	Rating
Environmental Suit Operation	43
Leadership	72
Marksmanship, Modern Weapons	64
Personal Combat, Unarmed	61
Security Procedures	21
Small Unit Tactics	36
Streetwise	27
Zero-G Operations	37

Notes:

Mbandwe is intensely loyal to the Corps and to Commander Gray.

Name: ABRAMS, Don
Rank/Title: Corporal
Current Assignment: Military Operations Command
USS File, NCC 2572

Position: Squad Leader

Race: Human
Sex: Male

Attributes:

STR - 67	CHA - 44
END - 74	LUC - 73
INT - 60	PSI - 18
DEX - 73	

Significant Skills	Rating
Environmental Suit Operation	37
Marksmanship, Modern Weapons	56
Personal Combat, Unarmed	49
Security Procedures	22
Small Unit Tactics	31
Streetwise	20
Zero-G Operations	28

Name: KOSHINARA, Iesu
Rank/Title: Private
Current Assignment: Military Operations Command
USS File, NCC 2572

Position: Marine

Race: Human
Sex: Male

Attributes:

STR - 68	CHA - 44
END - 63	LUC - 66
INT - 54	PSI - 12
DEX - 70	

Significant Skills	Rating
Environmental Suit Operation	39
Marksmanship, Modern Weapons	62
Personal Combat, Unarmed	47
Security Procedures	16
Small Unit Tactics	36
Streetwise	24
Zero-G Operations	2

ROMULANS

Commander Tal and his Sub-Commanders Avolus and S'marus are fairly important NPCs, and thus have been generated in detail. It is possible to use either or both of them as player characters if the gamemaster so desires. In that event, brief the player who will take the role about the Romulan part in the adventure.

The senior Romulan officers aboard the *Deletham Mosarum*, Sub-Commander Avolus's ship, are provided in less detail. They could be fleshed out for use as player characters, and are the primary members of the Doomsday Machine boarding party. Some typical guards, S'marus's men, are also briefly described so that they can be used in combat, if necessary.

Romulan squadron officers, the commanding officers of other ships, never actually appear in person. Refer to the **Vessels** chapter to obtain the officers' ratings in *Starship Combat Strategy/Tactics* and the Crew Efficiency Ratings of each ship.

Name: TAL

Rank/Title: Commander
Current Assignment: Exploration Division
Gallant Quest Squadron
Position: Squadron Commanding Officer

Race: Romulan

Age: 47

Sex: Male

Attributes:

STR - 75	CHA - 65
END - 74	LUC - 65
INT - 80	PSI - 47
DEX - 73	

Combat Statistics:

To-Hit Numbers —	Bare-Hand Damage: 1D10 + 8
Modern: 64	AP: 11
HTH: 62	

Significant Skills

Administration	Rating
Communications Systems Operation	77
Computer Operation	27
Damage Control Procedures	43
Deflector Shield Operation	30
Environmental Suit Operation	29
Gaming, Masaharis	20
Instruction	10
Language, Galacta	20
Leadership	36
Marksmanship, Modern Weapons	50
Negotiation/Diplomacy	54
Personal Combat	30
Dueling Stick	11
Unarmed	50
Planetary Science, Meteorology	20
Planetary Survival, Desert	10
Small Equipment Systems Operation	17
Social Sciences	
Romulan Culture/History	15
Romulan Law	30
Space Science, Astrogation	79
Sports, Swimming	15
Starship Combat Strategy/Tactics	78
Starship Helm Operation	78
Starship Sensors	39
Zero-G Operations	20

Distinguishing Physical Characteristics:

Tal is rather tall with a faraway gleam in his eyes. He is somewhat lighter in coloring than many of his compatriots.

Brief Personal History:

Birthplace: Vallassa, Rav's

After three very successful tours in the Military Division, then Sub-Commander Tal had the misfortune of becoming involved in the *Enterprise* Incident. He was greatly criticized for allowing a Federation vessel to whisk away both his cloaking device and his Commander from under the guns of his squadron's ships. Though he is less to blame than his Commander, Tal was transferred to an obscure post in the Colonization Division for many years. He eventually succeeded in overcoming his past shame and winning an appointment as a Commander over a squadron of exploratory ships in the Outback region. He has been in charge of operations close to the UFP border, and has coordinated espionage and intelligence missions as well as straight exploration.

Personality:

Motivations/Desires/Goals:

Tal has but one goal: to redeem the shameful stain on his record through some glorious triumph over the Federation. He hopes to combine such a triumph with personal death so that his final act will be hailed as *d'latta* (*The Great Death*).

Winning the Doomsday Machine for the Star Empire would be the kind of success Tal needs for his own self-esteem. Failing this, he is certain to use the Kirk Defense with his own flagship, sacrificing himself (and his men) to deny the UFP the working technology of the Machine.

Manner:

If anything, Tal is more dour, harsh, and suspicious than he was twelve years ago when he confronted the *Enterprise*. His position commands respect and obedience, but his own leadership lacks the flair that inspires intense loyalty. He is also too moody and aloof to lead his men as they deserve.

Tal is cunning, and knows when to shield attack with soft words. In all his dealings, he is very careful to offer no unbreakable oaths of honor to the Federation, but cleverly disguises this refusal.

Special Knowledge/Powers:

Masaharis is a Romulan strategy game, roughly analogous to a multi-player diplomacy boardgame from Terra.



Tal



Avolus



S'Marus

Name: AVOLUS

Rank/Title: Sub-Commander (reserve)/Shipmaster

Current Assignment: Inactive duty

Serving on merchant ship *Deletham Mosarum*

Position: Commanding Officer

Race: Romulan

Age: 52

Sex: Male

Attributes:

STR -70	CHA -79
END -70	LUC -61
INT -71	PSI -60
DEX -66	

Combat Statistics:

To-Hit Numbers —	Bare-Hand Damage: 1D10 +6
Modern: 53	AP: 10
HTH: 48	

Significant Skills

	Rating
Administration	30
Communications Systems Operation	80
Damage Control Procedures	72
Environmental Suit Operation	43
Gaming, S'dara	10
Instruction	20
Language	
Galacta	43
Klingonaase	52
Leadership	68
Marksmanship, Modern Weapons	39
Negotiation/Diplomacy	72
Personal Combat	
Duelling Stick	29
Unarmed	30
Planetary Science, Geology	10
Planetary Survival, Arctic	10
Small Equipment Systems Operation	46
Social Sciences	
Romulan Culture/History	15
Romulan Law	10
Space Science, Astrogation	56
Sports, Track and Field	15
Starship Combat Strategy/Tactics	42
Trade and Commerce	43
Zero-G Operations	51

Distinguishing Physical Characteristics:

Avolus is tall and gaunt. The left side of his face was badly burned in an explosion a year ago. He has lost the use of his left eye, and wears a special version of the Romulan helmet to cover the scarred flesh.

Brief Personal History:

Birthplace: Perhones

After many years of service as a Communications Officer in the Triangle, Avolus became a Sub-Commander in charge of a major listening outpost. Shortly thereafter, he received a ship command (an S-9 Class scout, not unlike the ship he now commands). This ended disastrously in the ship's destruction, which also scarred Avolus beyond repair by Romulan surgeons. He retired from active service, but has been given a special post as shipmaster (and sometime Intelligence Officer) in the Outback and along the Federation frontier.

Personality:

Motivations/Desires/Goals:

Avolus is dedicated to the Romulan Way, but exposure to the Federation has softened his opinions regarding the UFP as the Star Empire's natural enemy. He enters into negotiations with the *Fife's* Captain with good intentions, believing that working with the Federation against the Domsday Machine is best for all concerned. However, Avolus will not hesitate to obey Tal's orders, though he might pause to salute his foes and temporary allies when there is time to spare for sentiment.

Manner:

The Romulan Sub-Commander is charming and persuasive, despite his one-sided mask. Over the years, he has gained a great deal of experience in diplomatic activities, and uses the experience to put others at ease.

Special Knowledge/Powers:

S'darha is an extremely intellectual game that involves reciting stanzas from great Romulan literature to support a given argument or statement. It is a combination of debating, rhetoric, declamation, and trivia games.

Name: S'MARUS

Rank/Title: Sub-Commander

Current Assignment: Exploration Division

Gallant Quest Squadron

Position: Flagship Commanding Officer

Race: Romulan

Age: 51

Sex: Female

Attributes:

STR -68	CHA -77
END -70	LUC -31
INT -75	PSI -50
DEX -69	

Combat Statistics:

To-Hit Numbers —	Bare-Hand Damage: 1D10 +10
Modern: 82	AP: 10
HTH: 72	

Significant Skills

	Rating
Administration	42
Cloaking Device Technology	10
Cloaking Procedures	61
Computer Operation	56
Damage Control Procedures	20
Environmental Suit Operation	43
Gaming, Masaharis	10
Instruction	20
Language, Galacta	19
Leadership	71
Marksmanship, Modern Weapons	87
Negotiation/Diplomacy	10
Personal Combat	
Duelling Stick	5
Unarmed	75
Planetary Science, Meteorology	10
Planetary Survival, Desert	15
Small Equipment Systems Operation	20
Small Unit Tactics	54
Social Sciences	
Romulan Culture/History	15
Romulan Law	10
Space Science, Astrogation	10
Sports, Swimming	10
Starship Combat Strategy/Tactics	81
Starship Sensors	64
Starship Weaponry Operation	68
Zero-G Operations	41

Distinguishing Physical Characteristics:

S'marus is a very attractive Romulan female of average height and slim build.

Brief Personal History:

Birthplace: Hannrieth

Sub-Commander S'marus has a long but rather uneventful service history. Prior to this assignment, she saw much action in the Triangle. S'marus was originally to have received a promotion to command the squadron, but was superseded by Tal at the last minute.

Personality:

Motivations/Desires/Goals:

S'marus is a fanatic on the subject of the Federation, having lost a brother and an uncle in clashes with Star Fleet over the past 15 years. She hates, fears, and mistrusts UFP characters, and is only too happy to carry out orders to double-cross the *Fife* boarding party contingent.

Unlike a Human officer, S'marus harbors no particular resentment toward Tal for taking the post she should have had. However, though she and Tal see eye to eye on the subject of the Federation, she secretly despises him as a failure. She also feels nothing but contempt for Avolus, particularly when the latter is appointed as her nominal superior.

Manner:

S'marus has a haughty, arrogant manner. She embodies the worst of the noble Romulans. Few of the redeeming features of Romulan character shine through her disdain for weakness.

Special Knowledge/Powers:

None.

Name: CORNILUS
Rank/Title: Centurion
Current Assignment: Inactive Reserve
Position: First Officer
Race: Romulan
Sex: Male
Attributes:

STR -74 CHA -71
 END -72 LUC -32
 INT -61 PSII -01
 DEX -63

Significant Skills	Rating
Computer Operation	40
Deflector Shield Operation	67
Environmental Suit Operation	27
Marksmanship, Modern Weapons	51
Personal Combat, Unarmed	46
Small Equipment Systems Operation	38
Space Science, Astrogation	64
Starship Combat Strategy/Tactics	64
Starship Helm Operation	74
Starship Sensors	64
Zero-G Operations	35

Name: SEVUS
Rank/Title: Centurion
Current Assignment: Inactive Reserve
Deletham Mosarum
Position: Chief Engineer
Race: Romulan
Sex: Female
Attributes:

STR -77 CHI -63
 END -73 LUC -32
 INT -71 PSI -04
 DEX -64

Significant Skills	Rating
Computer Operation	46
Environmental Suit Operation	43
Marksmanship, Modern Weapons	41
Mechanical Engineering	69
Personal Combat, Unarmed	49
Shuttlecraft Technology	61
Small Equipment Systems Operation	52
Space Science, Astronautics	69
Warp Drive Technology	71
Zero-G Operations	33

Name: LENETUS
Rank/Title: Centurion
Current Assignment: Inactive Reserve
Deletham Mosarum
Position: Science Specialist
Race: Romulan
Sex: Female
Attributes:

STR -64 CHA -57
 END -72 LUC -55
 INT -71 PSI -56
 DEX -70

Significant Skills	Rating
Computer Operation	67
Computer Technology	77
Electronics Technology	67
Environmental Suit Operation	40
Marksmanship, Modern Weapons	48
Personal Combat, Unarmed	51
Physical Science, Computer Science	62
Small Equipment Systems Operation	47
Starship Sensors	76
Zero-G Operations	53

Name: MARSUS
Rank/Title: Centurion
Current Assignment: Inactive Reserve
Deletham Mosarum
Position: Cargo Officer
Race: Romulan
Sex: Female
Attributes:

STR -85 CHA -67
 END -84 LUC -12
 INT -74 PSI -01
 DEX -71

Significant Skills	Rating
Administration	69
Computer Operation	70
Environmental Suit Operation	54
Leadership	65
Marksmanship, Modern Weapons	42
Negotiation/Diplomacy	68
Personal Combat, Unarmed	40
Small Equipment Systems Operation	43
Trade and Commerce	78
Zero-G Operations	49

Name: STARVUS
Rank/Title: Trinam
Current Assignment: Inactive Reserve
Deletham Mosarum
Position: Support Engineer
Race: Romulan
Sex: Male
Attributes:

STR -79 CHA -63
 END -75 LUC -33
 INT -67 PSI -01
 DEX -72

Significant Skills	Rating
Cloaking Device Technology	67
Computer Operation	56
Computer Technology	64
Deflector Shield Technology	65
Environmental Suit Operation	46
Life Support Systems Technology	65
Marksmanship, Modern Weapons	50
Personal Combat, Unarmed	49
Small Equipment Systems Operation	53
Starship Weaponry Technology	70
Transporter Systems Technology	71
Zero-G Operations	47

Name: LISSINOI
Rank/Title: Centurion
Current Assignment: Exploration Division
S'ten
Position: Security Chief
Race: Romulan
Sex: Male
Attributes:

STR -72 CHA -47
 END -82 LUC -15
 INT -69 PSI -65
 DEX -69

Significant Skills	Rating
Environmental Suit Operation	46
Marksmanship, Modern Weapons	61
Personal Combat, Unarmed	69
Personal Weapons Technology	46
Security Procedures	66
Small Equipment Systems Operation	53
Small Unit Tactics	77
Social Sciences, Romulan Law	40
Zero-G Operations	48

Notes:
 Assigned by Tal to S'marus's boarding party.

Name: VEL
Rank/Title: Secundum
Current Assignment: Exploration Division
S'ten
Position: Security Guard

Race: Romulan
Sex: Male

Attributes:

STR - 79	CHA - 60
END - 74	LUC - 30
INT - 68	PSI - 30
DEX - 69	

Significant Skills	Rating
Environmental Suit Operation	30
Marksmanship, Modern Weapons	59
Personal Combat, Unarmed	55
Personal Weapons Technology	28
Security Procedures	67
Small Equipment Systems Operation	39
Small Unit Tactics	55
Social Sciences, Romulan Law	41
Zero-G Operations	32

Notes:
Assigned by Tal to S'marus.

Name: ANNUNUM
Rank/Title: Equatorium
Current Assignment: Exploration Division
S'ten
Position: Security Guard

Race: Romulan
Sex: Male

Attributes:

STR - 79	CHA - 60
END - 70	LUC - 31
INT - 61	PSI - 34
DEX - 81	

Significant Skills	Rating
Environmental Suit Operation	19
Marksmanship, Modern Weapons	50
Personal Combat, Unarmed	53
Security Procedures	50
Small Equipment Systems Operation	35
Small Unit Tactics	45
Social Science, Romulan Law	39
Zero-G Operations	20

Notes:
Assigned by Tal to S'marus.

CREW OF THE PRIDE O'RIGEL

Name: O'FLAHERTY, Patrick
Rank/Title: Master
Current Assignment: Free Trader Pride O'Rigel
Position: Captain

Race: Human
Age: 37
Sex: Male

Attributes:

STR - 60	CHA - 89
END - 62	LUC - 79
INT - 71	PSI - 01
DEX - 60	

Combat Statistics:
To-Hit Numbers — Bare-Hand Damage: 1D10 + 8
Modem: 62 AP: 10
HTH: 56



Significant Skills	Rating
Administration	42
Carousing	61
Communication Systems Operation	21
Computer Operation	24
Computer Technology	14
Electronics Technology	17
Environmental Suit Operation	51
Gaming, Cards	64
Languages	
Orion	39
Romulan	15
Leadership	77
Marksmanship, Modern Weapons	63
Negotiation/Diplomacy	64
Personal Combat	
Knife	33
Unarmed	51
Starship Combat Strategy/Tactics	21
Starship Helm Operation	47
Streetwise	81
Trade and Commerce	72
Transporter Operational Procedures	16
Value Estimation	37
Zero-G Operations	51

Distinguishing Physical Characteristics:

Usually wearing his yellow synthetic vest, O'Flaherty is tall and lanky. His eyes, hair, and goatee are gray. His speech is filled with the lilt of an Irish brogue, and he is rarely without a broad grin on his face.

Brief Personal History:

Birthplace: Dublin, Ireland, Terra

O'Flaherty left his poor Irish upbringing behind at the age of 17, when he lied about his age and signed aboard a tramp steamer out of Glasgow Star Port. In the years that followed, he bounced from ship to ship, learning everything he could.

He eventually found backing from a wealthy Argelian art collector, who put him in command of the free trader *Pride O'Rigel*. With this ship, O'Flaherty began working out of the Orion Colonies, smuggled precious works of art to his hedonistic employer, always one step ahead of Star Fleet enforcement units. The abrupt death of his patron (killed on Axanar by a jealous husband) exposed much of the man's shadier deals. O'Flaherty fled to the Outback region, changed several crucial registry records, and resumed his wily ways.

Personality:

Motivations/Desires/Goals:

All his life, O'Flaherty has wanted to make a really big score, a job that would set him up for life and leave a legacy for his children (he has several, by a number of different wives, some of whom he actually married legally) so that they will not grow up as poor as he did. More than money, though, the Irishman craves the challenge of making a living from smooth talking and fast wits.

O'Flaherty is convinced he can profit from his discovery of the Machine, though he is not quite sure how. This leads him to take action that either involves him at the worst possible times, or complicates the issue a little bit more.

He has a low opinion of Star Fleet (he has made fools of them often in the past) and a great deal of respect for Romulan efficiency. This leads him into trouble in his various dealings.

Manner:

Pat O'Flaherty (only a handful of men can get away with calling him "Paddy") is the epitome of the smooth-talking con man. He makes Cyrano Jones look like a dolt and Harry Mudd seem a veritable buffoon. This is not to say that O'Flaherty is as good as he thinks he is. He generally "lets his Warp 8 mouth outrun his Warp 1 mind," as one of his crew puts it. He is a lot better at hatching schemes than he is at coming up with solid ways of making them pay off. ("Can't cut solid neutronium?" he is likely to say at one point. "Sure, an' I niver gave it a thought!")

O'Flaherty is charming, convincing, and affable, the kind of man no one can stay mad at long. He could probably con a Klingon out of his hobnailed boots and sell them right back to him. He will never take a straight course when a con will do the trick. All in all, a likeable but untrustworthy rogue.

Special Knowledge/Powers:

None.

Name: MANKOVICH, Alexander "Zap"
Rank/Title: Mate
Current Assignment: Free Trader *Pride O'Rigel*
Position: Chief Officer

Race: Human
Sex: Male

Attributes:

STR -64	CHA -43
END -57	LUC -49
INT -47	PSI -11
DEX -71	

Combat Statistics:

To-Hit Numbers — Bare-Hand Damage: 1D10 +9
Modern: 82 AP: 11
HTH: 70

Significant Skills

	Rating
Computer Operation	24
Electronics Technology	39
Environmental Suit Operations	51
Marksmanship, Modern Weapons	89
Personal Combat	
Knife	46
Unarmed	69
Starship Weaponry Operation	29
Zero-G Operation	67

Notes:

A small but heavy-set and bullish man, Mankovich looks like a fighter and has a killer's disregard for life. He is personally devoted to O'Flaherty.

Name: GUTZMAN, Eric "The Red"

Rank/Title: Purser
Current Assignment: Free Trader *Pride O'Rigel*
Position: Cargo Officer

Race: Human
Sex: Male

Attributes:

STR -47	CHA -33
END -51	LUC -39
INT -81	PSI -21
DEX -51	

Combat Statistics:

To-Hit Numbers — Bare-Hand Damage: 1D10 +3
Modern: 43 AP: 9
HTH: 45

Significant Skills

	Rating
Computer Operation	67
Computer Technology	79
Electronics Technology	57
Marksmanship, Modern Weapons	34
Personal Combat, Unarmed	84
Small Equipment Systems Operation	63
Small Equipment Systems Technology	49

Notes:

Eric the Red is aboard the *Pride* to work off a debt to O'Flaherty. He does not much like his crewmates, and would gladly desert their cause if he thought he could get away with it. His expertise in computers comes from his early life, when he graduated at the top of his class from a prestigious university on Terra with a degree in *Computer Technology*.

Name: GIBBS, Joseph
Rank/Title: Engineer
Current Assignment: Free Trader *Pride O'Rigel*
Position: Chief Engineer

Race: Human
Sex: Male

Attributes:

STR -53	CHA -34
END -61	LUC -47
INT -71	PSI -10
DEX -58	

Combat Statistics:

To-Hit Numbers — Bare-Hand Damage: 1D10 +8
Modern: 47 AP: 9
HTH: 55

Significant Skills

	Rating
Computer Operation	22
Damage Control Procedures	49
Electronics Technology	57
Life Support Systems Technology	68
Marksmanship, Modern Weapons	39
Personal Combat, Unarmed	53
Space Science, Astronautics	73
Starship Weaponry Technology	38
Warp Dive Technology	81
Zero-G Operations	47

Notes:

An ex-Star Fleet Chief Petty Officer, Gibbs was forced to resign because his preferences for jury-rigged makeshift repairs failed to meet the standards of the service. Gibbs is happy aboard the *Pride*, but he still thinks back with longing to his Star Fleet days. He is unlikely to condone violence against the *Fife's* crew, but he will not fight against O'Flaherty.

Name: ROCHE, Peter

Rank/Title: Mate
Current Assignment: Free Trader *Pride O'Rigel*
Position: Navigator

Race: Human
Sex: Male

Attributes:

STR -62	CHA -50
END -54	LUC -80
INT -65	PSI -1
DEX -60	

Combat Statistics:

To-Hit Numbers — Bare-Hand Damage: 1D10 +8
Modern: 52 AP: 01
HTH: 58

Significant Skills

	Rating
Computer Operation	48
Deflector Shield Technology	42
Environmental Suit Operation	30
Marksmanship, Modern Weapons	43
Personal Combat, Unarmed	55
Space Science, Astrogration	67
Starship Helm Operation	60
Zero-G Operations	38

Notes:

Roche is quiet, competent, and carries out his orders to the letter. Though intelligent, he shows little initiative.

Name: ZANNAKIR, Ibmar
Rank/Title: Mate
Current Assignment: Free Trader *Pride O'Rigel*
Position: Helmsman

Race: Orion

Sex: Male

Attributes:

STR - 76	CHA - 56
END - 65	LUC - 57
INT - 69	PSI - 45
DEX - 55	

Combat Statistics:

To-Hit Numbers —	Bare-Hand Damage: 2D10 + 5
<i>Modern:</i> 50	AP: 9
<i>HTH:</i> 57	

Significant Skills

	Rating
Computer Operation	44
Environmental Suit Operation	31
Marksmanship, Modern Weapons	43
Personal Combat, Unarmed	58
Physical Sciences, Mathematics	51
Space Science, Astrogation	53
Starship Helm Operation	66
Starship Weaponry Operation	33
Zero-G Operations	46

Notes:

The only non-Human in O'Flaherty's crew, Zannakir is fleeing from both Orion and Federation justice in connection with the murder of a Caltian shipping magnate. He does his best to keep a low profile, and he will hold out to the last if forced to fight Star Fleet.

Name: KERTZER, Peter "Babe"

Rank/Title: Apprentice

Current Assignment: Free Trader *Pride O'Rigel*

Position: Communications/Weapons Officer

Race: Human

Sex: Male

Attributes:

STR - 69	CHA - 79
END - 64	LUC - 80
INT - 56	PSI - 64
DEX - 59	

Combat Statistics:

To-Hit Numbers —	Bare-Hand Damage: 1D10 + 7
<i>Modern:</i> 49	AP: 9
<i>HTH:</i> 54	

Significant Skills

	Rating
Communications Systems Operation	67
Communications Systems Technology	26
Computer Operation	35
Damage Control Procedures	26
Electronics Technology	44
Marksmanship, Modern Weapons	37
Personal Combat, Unarmed	41
Starship Weaponry Operation	37

Notes:

Younger than his comrades, Kertzer is a bit more naive. This is his first trip with O'Flaherty, and he had no idea it would involve pulling weapons on Star Fleet officers. He is likely to freeze in a crisis.

Name: IORIZZO, Antonio "Crazy Tony"

Rank/Title: Second Mate

Current Assignment: Free Trader *Pride O'Rigel*

Position: Junior Navigator/Watchstander

Race: Human

Sex: Male

Attributes:

STR - 64	CHA - 51
END - 68	LUC - 50
INT - 55	PSI - 09
DEX - 68	

Combat Statistics:

To-Hit Numbers —	Bare-Hand Damage: 1D10 + 7
<i>Modern:</i> 61	AP: 10
<i>HTH:</i> 44	

Significant Skills

	Rating
Communications Systems Operation	39
Deflector Shield Technology	32
Marksmanship, Modern Weapons	54
Personal Combat	
Knife	85
Unarmed	40
Space Science, Astrogation	60
Starship Helm Operation	59
Transporter Systems Technology	36

Notes:

Crazy Tony lives up to his name. Though not exactly psychotic, he loves sharp instruments, has an unnerving stare, and reacts sharply to even a hint of criticism.

Name: HAWKE, Calvin "Doc"

Rank/Title: MD

Current Assignment: Free Trader *Pride O'Rigel*

Position: Ship's Doctor

Race: Human

Sex: Male

Attributes:

STR - 51	CHA - 60
END - 46	LUC - 37
INT - 66	PSI - 36
DEX - 49	

Combat Statistics:

To-Hit Numbers —	Bare-Hand Damage: 1D10 + 5
<i>Modern:</i> 36	AP: 8
<i>HTH:</i> 38	

Significant Skills

	Rating
Environmental Suit Operation	24
Life Support Systems Technology	42
Marksmanship, Modern Weapons	22
Medical Sciences	
General Medicine, Human	64
General Medicine, Orion	37
Surgery	48
Personal Combat, Unarmed	25
Zero-G Operations	39

Notes:

Doc is a drunkard who could not get employment anywhere except in space. Only a shady operator like O'Flaherty, who does not care much about appearances, would hire him. When he is sober, Hawke is competent. He is rarely sober.

Name: CURREN, Edward "Fast Eddie"
Rank/Title: Engineer's Mate
Current Assignment: Free Trader *Pride O'Rigel*
Position: Junior Engineer

Race: Human
Sex: Male

Attributes:

STR - 69	CHA - 80
END - 63	LUC - 85
INT - 62	PSI - 01
DEX - 55	

Combat Statistics:
 To-Hit Numbers — Bare-Hand Damage: 1D10 + 7
Modern: 47 AP: 9
HTH: 51

Significant Skills	Rating
Communications Systems Technology	47
Computer Technology	35
Environmental Suit Operation	33
Marksmanship, Modern Weapons	38
Mechanical Engineering	61
Personal Combat, Unarmed	46
Personal Weapons Technology	22
Small Equipment Systems Technology	
Zero-G Operations	26

Notes:
 Curren, like O'Flaherty, is a natural-born con man. As he is on the run from Star Fleet for trafficking in Orion slave girls, he would prefer not getting involved at Ectair. He has no choice, however, because O'Flaherty is running the show.

ECTAIRIANS

Name: MOZINPHAR, Amehda
Rank/Title: Master of Ectair
Position: Head of State

Race: Orion
Sex: Male

Attributes:

STR - 63	CHA - 48
END - 60	LUC - 65
INT - 53	PSI - 69
DEX - 59	

Significant Skills	Rating
Administration	38
Language, Galacta	48
Leadership	22
Negotiation/Diplomacy	25



Name: KING, Burton C.
Rank/Title: President
Position: Chief Executive Officer of Kinglines, Inc.

Race: Human
Sex: Male

Attributes:

STR - 57	CHA - 58
END - 54	LUC - 64
INT - 71	PSI - 35
DEX - 51	

Significant Skills	Rating
Administration	70
Leadership	55
Negotiation/Diplomacy	63

Name: WHITTAKER, Perry
Rank/Title: Captain
Current Assignment: Merchant Line (Kinglines, Inc.)
Cosmos Royale
Position: Commanding Officer

Race: Human
Sex: Male

Attributes:

STR - 65	CHA - 67
END - 63	LUC - 28
INT - 68	PSI - 21
DEX - 60	

Combat Statistics:
 To-Hit Numbers — Bare-Hand Damage: 1D10 + 6
Modern: 45 AP: 10
HTH: 48

Significant Skills	Rating
Electronics Technology	35
Marksmanship, Modern Weapons	30
Personal Combat, Unarmed	36

TYPICAL BUREAUCRATS

Attributes:

STR - 50 + 2D10	CHA - 40 + 2D10
END - 50 + 2D10	LUC - 1D100
INT - 50 + 1D10	PSI - 1D100 - 30
DEX - 50 + 2D10	

Significant Skills	Rating
Administration	40 + 3D10
Negotiation/Diplomacy	20 + 3D10

Notes:
 Bureaucrats may be encountered when dealing with Mozinphar or King, or as passengers aboard the *Cosmos Royale*.

TYPICAL BODYGUARDS

Attributes:

STR - 60 + 2D10	CHA - 50 + 1D10
END - 60 + 2D10	LUC - 1D100
INT - 50 + 1D10	PSI - 1D100 - 30
DEX - 60 + 2D10	

Significant Skills	Rating
Marksmanship, Modern Weapons	30 + 3D10
Personal Combat, Unarmed	40 + 2D10

Notes:
 Bodyguards are available to both Mozinphar and King if they are physically threatened or wish to remove unwanted guests. They are also found as ship's police aboard the liner.

TYPICAL CREWMEN

Attributes:

STR - 50 + 2D10	CHA - 50 + 1D10
END - 50 + 2D10	LUC - 1D100
INT - 60 + 1D10	PSI - 1D100 - 30
DEX - 50 + 2D10	

Significant Skills	Rating
Personal Combat, Unarmed	42

Notes:
 Crewmen will be encountered aboard the *Cosmos Royale*. See the encounter descriptions in *The Adventure* for details.

GAMEMASTER'S NOTES

A **Doomsday Like Any Other** is an adventure with many layers and hidden elements that can change the tone and complexion of play according to the way the players choose to react to the unfolding situation.

There are several opportunities for intensive interaction. Whether they are dealing with Ectairians, Romulans, or O'Flaherty's motley crew, the player characters will be facing some determined and totally opposing viewpoints that must be overcome in one way or another. But there is also a chance, given good role playing, that the personalities of individual player characters will come into conflict with one another. The characters by background and the players by nature are likely to have some disagreements about many aspects of the situation. For example, when is force justified in solving the problem of obtaining the *Cosmos Royale*? What should happen next when the liner does not destroy the Doomsday Machine? How will they react to the Romulans? An intense interplay of viewpoints is much more the essence of a good adventure than any awesome pyrotechnics, and this can be as true of a role-playing scenario as it is for a television episode.

The Captain in particular will find this situation a trying one. Other characters have more of a chance to use a variety of skills to solve problems, but the Captain's chief role here will be to make difficult decisions. He has a number of specific and often contradictory orders to carry out, and he must walk a fine line between the destruction of a planet, on one hand, and diplomatic or military disasters on the other. The Captain of the *Fife* has sole responsibility for everything that happens, and the gamemaster must be sure to emphasize this fact when he sets the stage for the adventure. The Captain's performance must be measured against the standards of Star Fleet, which means he cannot stop the Doomsday Machine at the expense of morals or ethics.

HINTS ON PLAY

The following sections provide general suggestions to the gamemaster on how to run this and other adventures.

ADVENTURE FLOW CHART

In the first portion of the adventure, there are many routes the player characters can take. The Adventure Flow Chart has been developed to help the gamemaster decide how events will take place.

The sections of the text in **The Adventure** should be followed sequentially until play reaches the **Captain's Choices** section. From here, the decisions made by the group will dictate what section is next consulted.

CLUES AND CLUE-DROPPING

Although it has its violent side, a great deal of this adventure is built around investigation of mysterious alien technology. It may require a certain amount of inspired thinking on the part of the players to solve some of the finer points of the problems they face.

Unfortunately, just because a player is supposed to be a Vulcan with a fantastically high intelligence, a logical and analytical mind, and the best scientific training Star Fleet can provide, the player may not be able to think his way through a maze that most laboratory mice could solve in a matter of minutes. This puts a burden of responsibility on the gamemaster to see to it that the players have a chance to think for themselves, but are still not handicapped by the differences between their own abilities and experience and those of the characters they portray.

Where possible, players should solve their problems on their own. There are a number of subtle clues, inconsistencies, and odd turns built into the adventure that should be offered without comment or special emphasis in the hopes that the players will pick up on them and act appropriately.

ADVENTURE FLOW CHART

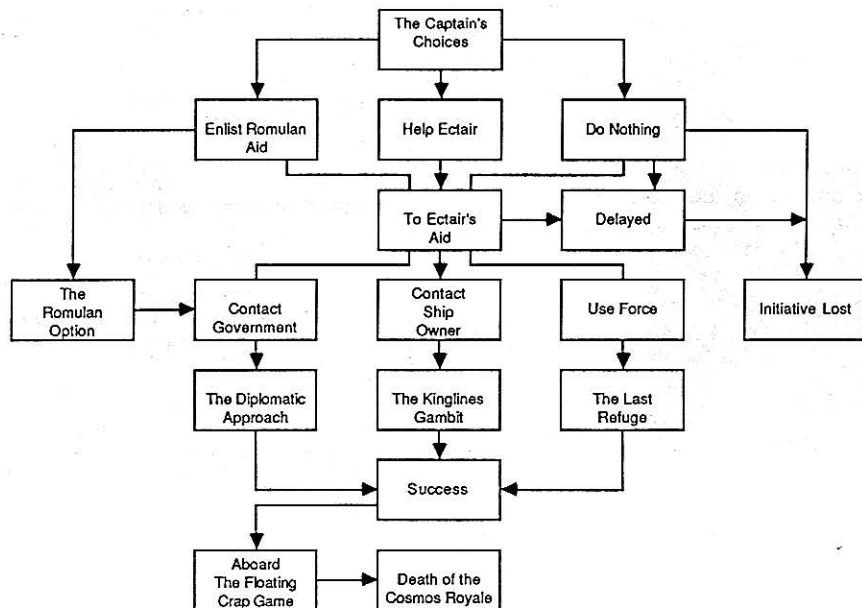

If this does not happen, the gamemaster may wish to subtly repeat the clue or hint. If the players are missing obvious things that are crucial to the successful outcome of the adventure (the usefulness of the beacon pod, for example), an NPC can discover its significance.

When the players are in a situation where a silly oversight or rash action could endanger them all (as in the computer room, when two examinations are required to learn all the possible pitfalls of the disconnect/destruct processes), allow them a Saving Roll against the average of their INT and LUC scores. If successful, the gamemaster can give broad or subtle hints to warn them away from a course of action or at least make them stop and think twice.

Players who refuse to exercise their brains, particularly those in especially responsible positions, deserve anything they get. Suggest that their next character be something less demanding, like a typical cannon-fodder Security officer, until they learn that brains, not muscles, are the principle tools of Star Fleet.

PACING

Pacing is important in this adventure, as players must be aware of the passage of time and the looming Doomsday deadline. Equally, they must have time to think and to act. Under no circumstances, however, should they become so bogged down that they become bored with the proceedings.

Many of the tasks undertaken during the adventure require a great deal of time, possibly more than players will think is necessary. (Try deciphering a completely alien control panel and see how fast things move.) Such periods of research should move fairly swiftly, but should not be reduced to a series of die rolls. Spend a few minutes on each period, working the die roll into a discussion of what the characters have learned and discovered over the past half-hour. When working with NPCs, take some time to develop working relationships, particularly with the Romulans. Stop for occasional reports on the Machine's progress. Do not drag out completely trivial incidents to the point where they mask the primary concern of the adventure, which is to stop the Machine.

There will be quite a lot of action at various points in the game. One aspect of pacing is to know how to intersperse action and research. Both will be essential to the outcome of the adventure. Although it is the action that will hold the group's interest, it is the plodding research work that actually wins the day. To give players a crack at doing both, this is where they may use the secondary officers. Players may role play both sets of characters, solving the puzzles on the Machine and manning the bridge while the *Fife* makes attack runs to distract the Machine.

Never gamemaster one group too long before going back to the other, especially if some players are involved in only one of the groups. Plod through some of the descriptions and research for awhile, then shift scenes back to the *Fife*. From time to time, make the shift at an awkward moment. For example, the *Fife* has failed a *Starship Helm Operation* roll and is about to come under attack. Meanwhile, aboard the Machine... This is the essence of the commercial break on television: it keeps everyone involved in what is going on and anxious to find out what is going to happen next.

Pacing should start off fairly slowly, picking up gradually. If anything, the players should feel that the Machine threat is just a distraction of some kind. 'Everyone knows' that a Doomsday Machine can be destroyed by the Kirk Defense; let them think that this is just a way to introduce them to Ectair. The surprise and horror of having the whole *Cosmos Royale* incident fizzle makes a nice turning point in the adventure, after which desperation sets in. Thereafter, things should start moving much faster, as the characters get involved with greedy rogues, Romulans, attacks on the Machine, an exploration of an alien artifact, and a crescendo of action involving a firefight inside and a space battle outside. Properly handled, this adventure should be like a good roller coaster ride, with the players ending up torn between gasps of relief and disappointment that the thrills are over.

ADVENTURE FLOW

This adventure, as mapped out in the text, is largely linear in nature; event follows event in a relatively orderly fashion. However, the experienced gamemaster will realize that the adventure will probably not be quite so well-defined. It is perfectly possible that the players will go off on a tangent.

When absolutely necessary, the players can be nudged back on track by some events. The Romulans are always present to lead the players, and they can be used if the players stray beyond all bounds of common sense. However, it is not smart to force the players to adopt the exact path outlined in **The Adventure**. Whenever possible, the gamemaster should go with the players' flow and see where it leads. Some fascinating alternatives might emerge. What if the Romulans gain sole possession of the beacon and solve its secrets, while the player characters are on some wild goose chase, for example? The adventure could end up a desperate affair, indeed. Other alternatives may be equally interesting.

The adventure is long and complex enough to be spread over several sessions. Its three major sections can serve as ideal stopping points. The first ends as the Kirk Defense fails to stop the Machine. The second ends with the characters faced with capture by the Romulans and then by O'Flaherty. The third session presents the solution to the whole affair. Each individual part will be radically different in tone, making for an interesting balance before the game's end.

ADVENTURE OUTCOMES

Obviously, there are many pitfalls and disasters, both personal and professional, awaiting the player characters in this adventure. Many of these, such as the penalties for mishandling various aspects of the Ectairian situation, are either spelled out in the text, or are painfully obvious. Even if the *Fife* were to somehow escape, loss of the Machine to the Romulans would be the worst setback to the Federation in recent memory. It would make the whole Genesis incident look petty by comparison. In similar fashion, bringing back the Machine intact would be a triumph of the first order, assuming nothing else disastrous occurs. (The Captain who sails into Star Base 8 aboard a Doomsday Machine, having abandoned his ship and crew to the Romulans, is not going to be given a hero's welcome, no matter what.)

The actual outcome will be somewhere in between, in all likelihood. The players' main concerns are these:

Stopping The Machine

Do not worry about capturing it, just save the Federation first.

Saving Ectair

This is important for public relations reasons. Trading a planet for the Machine is not a pleasant way to solve a problem.

Stopping The Romulans

As noted before, if the Romulans get the Machine, the Captain and his officers should not expect to command anything bigger than a rubber duckie in a bathtub again.

Saving The Ship

The *Fife* is an expensive piece of equipment, and no one likes to waste lives needlessly. If the ship and/or crew must be expended to achieve a higher goal, so be it. However, Star Fleet would like their ship back.

Good Diplomacy

Keeping on good terms with Ectair would be nice, but it is not essential.

Avoiding War

This is a prime concern. The Romulans may be the ones who start the trouble, but it is a wise Captain who knows when to break off pursuit. Remember, Ectair is not part of the Federation, and the planet claims responsibility for the Romulan action as a "defensive measure". This is a face-saving way out for all parties in the incident, and a Captain who fails to take it and gets the Federation embroiled in a major confrontation now will probably follow Admiral Kirk in line for the attentions of a court-martial board.

The weight of these various goals is fairly plain. The players who complete all of them successfully deserve letters of commendation all around.

SKILL RATING BONUSES

This adventure should bestow some skill rating increases. Any player or NPC who is successful in working with the beacon or a control room system should get a 1D10 increase in the skill rating(s) used. If two or more skills are involved in solving a single system (as with shutting down the computer), spread the points as desired between the two ratings.

Player characters should also receive a general fund of 10 to 20 points with which to increase any skill ratings for any skills used successfully in the course of the adventure. If used with any degree of success, the Captain's rating in *Negotiation/Diplomacy* should almost certainly be increased. The exact number of points granted should depend on the degree of participation in the adventure, the quality of play, and the importance of the player character's contribution to the final solutions.

At the gamemaster's option, player characters who interact extensively with the Romulans (and live to tell about it) should be given 20 points for use with acquiring Skill Ratings in areas such as *Language, Romulan, Romulan Culture/History, Psychology, Romulan, Negotiation/Diplomacy*, or other skills deemed suitable by the gamemaster. No one skill rating can be increased by more than 5 points, or to a level higher than 25, save that a skill not previously held can acquire a skill rating of up to 10.

The gamemaster should be careful in awarding skill point increases. Characters should receive rewards in line with their achievements, but this adventure is demanding enough to warrant fairly substantial skill rating increases.

ADAPTING TO ONGOING CAMPAIGNS

This adventure pits Star Fleet officers against a variety of problems. It may be even more interesting, however, to play the adventure from another point of view, though the gamemaster will be forced to improvise many more possible adventure paths as a result.

Players who prefer to use the **Trader Captains and Merchant Princes** supplement might have an interesting time playing this adventure as the Captain and crew of the *Pride O'Rigel*. The adventure could start with the encounter with the quiescent Doomsday Machine. Such a band of trader-adventurers would not be at all concerned about planet-saving or interstellar diplomacy, but they will be interested in making a profit. The result will likely be enough skullduggery to make Harry Mudd proud.

It would be equally fascinating to play Romulan characters, particularly Avolus and his crew. Dealing with Star Fleet and the plots of Commander Tal would make an interesting adventure. The **Romulans** supplement provides everything the players will need to make such an adventure possible.

Most challenging of all, though, is a scenario in which the players are split up among these conflicting groups. It will take much more effort on the part of the gamemaster (and probably the aid of a couple good assistants) to make the adventure work. With so many players, each in different groups and with different goals, decisions will rapidly shift the story line of the adventure outside the limits in these rules. Though complex, the situation would lend itself quite well to tournament play, leading to both conflict and cooperation as each group strives for its own objectives.

Gamemasters wishing to start a campaign involving a *Chandley* Class frigate can obtain the FASA adventure, **Where Has All The Glory Gone?**, and use it as a sequel to this one. The ship and crew from one adventure can be used in the other adventure, and the players will be on their way to launching their frigate's ongoing mission. Perhaps it will eclipse the *Enterprise* in the annals of Star Fleet.

SPECIAL GAME CONSIDERATIONS

The following sections discuss certain details that were glossed over in **The Adventure**.

DOOMSDAY DEADLINE

The passage of time is very important to the play of the adventure. When the *Fife* orbits Ectair, they have about 72 hours. To allow for delays along the way while the machine is digesting outer planets, the gamemaster should make it 70 + 2D10 hours, but he should not tell the players this. From this point on, it is important to keep track of time spent in negotiating, preparing the *Cosmos Royale*, dealing with O'Flaherty and the Romulans, and investigating the beacon and the Machine itself. Remember that the characters do need to eat and sleep.

Characters can push themselves to the limit and use stimulants, but there are risks. After twelve hours, characters should make Saving Rolls against their END scores to determine if that character needs to sleep. If successful, subtract 10 from his END if he stays awake. Repeat the process every twelve hours, but INT, LUC, and DEX also begin to drop by 10 points after the character has stayed awake for 24 hours. In addition, all skill ratings are decreased by 10 to reflect making mistakes due to fatigue.

When an END roll fails, the character must either sleep or resort to stimulants to keep functioning. While under the influence of stimulants, all attribute scores and skill ratings function as if at normal levels, but cumulative reductions are still noted. When a character's stimulants wear off and are not renewed, the full effect of fatigue is felt in addition to the usual damage from stimulant use. Reductions are strictly temporary, and the character will recover after spending at least one hour's sleep for every three hours of wakefulness.

Unlike most *ST:RPG* adventures, there is no timeline provided here, because character actions may be variable. The gamemaster should track passing time and interject necessary events as appropriate. If the players are moving so slowly as to jeopardize success, the Romulans can always seize the initiative and take action on their own. Also, it is possible to buy Ectair a great deal of time by distracting the Machine, but each attack runs the risk of disaster through a failed skill roll or as a result of the Doomsday Encounters Table.

BOARDING PARTY SIZE AND COMPOSITION

The Adventure section is deliberately vague regarding the desirable size for a boarding party. The players should control the size of the party. The Romulans will want to dispatch one person for every Star Fleet character sent, and O'Flaherty will leave only one of his men behind if he has any say about the size of his contingent. (If he cannot take this number, he will leave orders for them to follow later). Thus, the more characters the *Fife* sends over, the larger the number of Romulans. Remind the players that very large parties will become unwieldy, and encourage them to work with the Romulans by having the two parties send over complementary teams, rather than having each side send experts on everything. Of course, this could be costly later, when it turns out the Romulan specialists have mastered many of the important controls, but this only adds to the tension and heightens the excitement of the game.

It is important to leave a group of player characters aboard the *Fife*. There will be plenty for them to do: delaying the Machine and fighting off the Romulans. Contrary to what *STAR TREK* might lead people to believe, it is never a good idea to commit all a ship's senior officers to an expedition of this kind. Engineering and science personnel will be important, but not the entire bridge crew.

NEGOTIATING

There are several places where negotiations play a crucial part in the adventure. It is important, though, that negotiations not be so completely subject to die rolls that they become totally abstract. Role play all negotiating sessions, and use what is said to provide modifiers for encounter outcomes. Reward good ideas from the players, and let them try to bring other skills into play if they present plausible reasons for doing so. (*Psychology? Leadership?* Many skills are worthwhile when dealing with others, if the players choose to apply them.)

The gamemaster may decide the final outcome of any negotiating session. If it seems best to force the players to choose between Romulan aid and sending in the marines to take the *Cosmos Royale*, ignore the die rolls and do not allow the *Fife's* Captain to sway the Ectairian NPCs. Equally, if time is short and it seems better to speed things along, let the NPCs be more agreeable than the die rolls make them. Dice and tables form a framework around which

the gamemaster must tell a story, and the excitement of the story is far more important than absolute reliance on set rules as long as the players still get an even break in the end.

GAMEMASTERING NPCs

The gamemaster must be willing to work hard to see that all the many NPCs play their proper parts in shaping the course of the adventure. He can skip on some rules-oriented aspects of NPC use. For example, there is no need to worry too much about exact rolls when it comes time for two NPCs to fight with one another. Let the outcome suit the story as needed, but do not ignore NPC motivations and overall actions.

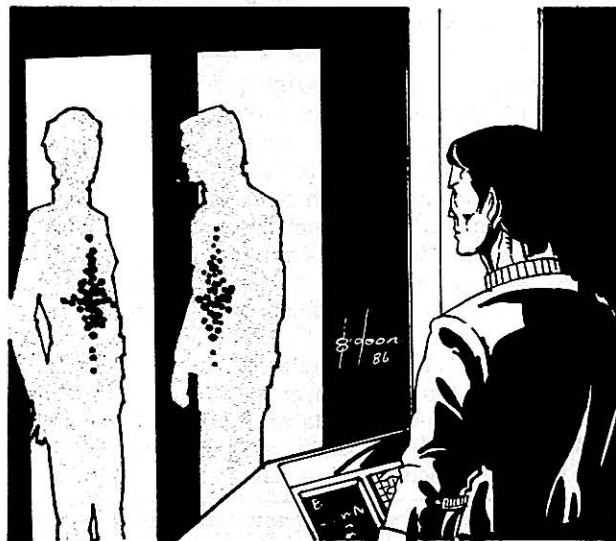

The Ectairians whom the player characters are likely to meet are a small clique of wealthy, powerful people primarily interested in saving themselves. Their position is analogous to that of an Albania or a North Korea: a small nation with powerful friends (the Romulans) that exploits the image of being a tiny underdog kicked around by the big, bad, imperialistic Federation. Because Ectair lies within Federation space, however, and because there are commercial concerns with a big interest in Ectairian/Romulan trade, the Federation cannot ignore the planet as effectively as the United States today can afford to ignore a place like Albania. These facts form the underlying basis for all interactions with the Ectairians.

O'Flaherty and his men provide special opportunities for the gamemaster. They complicate matters aboard the Machine, of course, and are villains to be overcome. But, like Harry Mudd, the Irish trader is a light villain. O'Flaherty is a person with a gift for causing trouble, but without the malice of some of the Romulans. It is up to the gamemaster to set the tone of things, portraying O'Flaherty as anything from a sinister heavy to a comical, bumbling incompetent. The best way to use him, though, is in a sort of middle ground. Although he can be dangerous, O'Flaherty also provides a degree of comic relief and a welcome contrast to the stony-faced Romulans. He (and the gamemaster) should enjoy himself immensely. Like Harry Mudd, he should probably escape unscathed to return again another day. (Even if he and his band are arrested, there is no need for them to stay arrested).

One entry in the **Players' Handout** refers to Aki Torimatsu, the UFP consul on Ectair, as a possible source of aid or assistance to the players in dealing with Ectair's government. On arrival at Ectair, the player characters will discover that Torimatsu, an elderly and rather obscure diplomat, has recently died in office. No replacement has yet arrived, and there are no other diplomatic officers at the small Federation Consulate to take his place. This makes it necessary for the player characters to handle all negotiations themselves.

If the players show a particular lack of ability in the area of diplomacy and the gamemaster feels a restraining presence is necessary, Torimatsu can be seriously ill instead of dead, capable of exerting intermittent but low-key influence over the course of events. Players should not, however, be allowed to lean very heavily on an NPC of this kind.

USING THE PLAYERS' HANDOUT

The Players' Handout is designed to prepare the players for some of the situations they face in the scenario. It is divided between computer files and briefing material.

The Captain should begin by reading his briefing and orders. He can decide how much to pass on to the other officers. Computer files may give away some of the problems, but they also contain much that is misleading (such as frequent references to the Gorns, who play no part in this scenario).

Some computer files refer to the availability of additional information. If a player is interested in something special, such as in-depth data on Ectair, he can make a Skill Roll against his character's rating in *Computer Operation* to retrieve that additional material.

GAMEMASTERING ROMULANS

The need to portray the Romulans in this adventure will require that the gamemaster have some knowledge of this warrior race. **The Romulans** supplement contains all the information a gamemaster will need to role play these foes of the Federation. Lacking that supplement, the notes below and the *STAR TREK* episodes "Balance of Terror" and "The *Enterprise* Incident" will provide an insight into handling these characters in the game.

THE ROMULAN CHARACTER

The Romulans are a race poor in worldly resources, often obtaining their survival needs through conquest. The guiding philosophy and goal in Romulan society is to build a Road to the Stars, or expand their empire through the galaxy. They believe that their early ancestors were transplanted to the world of Romulus by their gods, alien beings of immense power, who directed the people to build this road to the stars. They believe the gods themselves wait at the end of this road.

The lifestyle of a Romulan, the Romulan Way, consists of the disciplines needed to reach this great racial goal. Skillfully using their limited resources, Romulans live (and die) in a rigidly structured society where duty and religious conviction go hand in hand to meet their goals. If death will advance the Romulan cause more than life, then death is preferred. By keeping a few of these points in mind, Tal's actions and motivations throughout the story should be more clear.

COMMANDER TAL

The Romulans begin the adventure hoping primarily to score a propaganda victory, aiding Ectair where the Federation cannot. It is only when the beacon makes its appearance that Tal begins to see a way to get the Machine and to humble Star Fleet at the same time. A shrewd officer, and with a heritage closer to that of the Machine's builders than the Federation characters, Tal will probably guess that the Machine can be boarded as soon as the beacon's IFF transponder mechanism becomes obvious. This enables him to lay his trap. Do not ignore the personalities of the three principle Romulans. They are major characters whose attitudes should have a profound impact on the adventure's outcome.

Tal's squadron is a different matter. While engaged in exploration beyond the frontier, Tal's cloaked ships occasionally slip into Federation territory to gather intelligence. Commander Tal is a ruthless, bigoted, dangerous officer. Though he pretends friendship in the name of Ectair's safety, he is actually plotting to use the crew of the *Fife* until he no longer needs them, and then find a convenient way to discard them. He is not so crazy as to create an incident himself, but is waiting for any possible excuse. Once the Machine is deactivated, he plans to seize it and take it to Romulan space. The chance of gaining information on Doomsday Machine technology is worth any risk of an incident at Ectair. This is especially true if the Machine can be controlled.

Romulan plans and motives should be kept in mind through all aspects of the adventure. Tal wants the Machine, but he will be quick to take whatever action is necessary to keep the Machine from falling intact into the hands of the UFP. This may lead the Romulan Commander to sacrifice his life and the lives of his flagship's crew in a self-destruct attempt.

SPECIAL MODIFIERS FOR JUDGING ROMULANS

There are several special modifiers for judging combat when the encounter involves Romulans. The modifiers listed here are repeated from **The Romulans** supplement. They can be treated as optional, but are highly recommended.

DIFFERENCES IN STUN DAMAGE BETWEEN HUMANS AND ROMULANS

Stun Damage	Humans	Romulans (Or Vulcans)
Hit	75	70
Graze	25	25
Heavy Stun Damage		
Hit	120	110
Graze	40	40

Also, all Romulan and Vulcan characters have an **INACT SAVE LEVEL** of 15 instead of the 20 common to other races.

Romulan Hand Disruptor

To operate this weapon, a character must strap it onto the back of his hand, which will take about one minute (six turns). A safety feature prevents the weapon from firing when it is not strapped onto the hand (or a similarly-sized and -shaped object, including a hand in an environmental suit). It is always ready for use, so there is never an AP cost to draw or ready the weapon.

Because the Romulan-design disruptor fits on the back of the hand, it cannot be dropped accidentally or knocked out of the operator's hand. The exposed nature of the weapon, however, renders it somewhat vulnerable to damage. If the operator of such a weapon is involved in hand-to-hand combat and any damage is scored against him, make a Saving Roll against the average of the character's LUC score and his Skill Rating in *Personal Combat, Unarmed*. If the roll fails, the weapon is struck rather than the character. He takes no damage, but the weapon is rendered inoperative. The gamemaster may also require a Saving Roll against the character's LUC score if the character falls down a slope, is slammed against a wall, or otherwise flails about in a manner that might damage his weapon.

For purposes of this adventure, it will not be possible to recharge or repair any hand disruptors away from Romulan ships.

Plasma Bolt Weapon

The following rules revisions alter the damage effects of Romulan plasma weapons to more accurately reflect the destructive potential of these devices. The new rules spread the damage throughout the ship instead of concentrating it on one spot. They also allow lucky Commanders to maneuver their ships out of the way of a direct hit, taking only a graze. The same rules and procedures are used to handle combat with the Doomsday Machine's anti-proton weapon.

Graze Damage

When a player character ship (such as the *Fife*) is struck by a plasma weapon, the ship's Commander should make a Saving Roll against his LUC score. If the roll is successful, the Commander managed to maneuver his vessel out of the path of the bolt, causing it only to graze his ship. In this case, graze damage is only half as destructive as a normal hit. A gamemaster should disallow the Saving Roll in unusual circumstances, such as when the vessel is immobile, caught in a tractor beam, or otherwise handicapped. The Saving Roll can be allowed, optionally, to NPC ships.

Damage Table

The table below gives the total damage for each plasma weapon type (and the anti-proton beam, abbreviated APB) as a function of range. On the table, the damage number before the slash is the weapon's graze damage. This chart replaces those in the early editions of FASA's *STAR TREK* game line.

TOTAL DAMAGE FROM PLASMA BOLT WEAPONS

Range	RPL-1	RPL-2	RPL-3	APB
1	14/12	32/16	28/14	64/32
2	20/10	32/16	28/14	64/32
3	20/10	32/16	28/14	56/28
4	16/8	24/12	28/14	56/28
5	16/8	24/12	24/12	56/28
6	12/6	24/12	24/12	48/24
7	8/4	20/10	24/12	48/24
8	4/2	20/10	24/12	48/24
9	--	16/8	20/10	40/20
10	--	16/8	20/10	40/20
11	--	12/6	20/10	40/20
12	--	12/6	16/8	32/16
13	--	8/4	16/8	32/16
14	--	8/4	12/6	24/12
15	--	--	12/6	24/12

Spreading the Damage

A plasma bolt weapon or anti-proton beam that penetrates shielding may damage several systems because the effects of the bolt tend to spread (and the anti-proton beam is extremely powerful). Thus, damage taken from these attacks are spread among possible targeted systems. When a plasma bolt scores a hit, reduce damage according to shield strength. Then, for each 5 points of damage that got through the shield, roll for damage location. Continue rolling damage locations separately for each 5-point block until all damage is recorded.

SPACE MARINES

The *USS Fife* carries a contingent from the Star Fleet Marine Corps Command in addition to its regular crew. Well-trained for both combat and rescue situations under a wide variety of environmental conditions, marines serve in conjunction with every other command of Star Fleet's operating forces. They are skilled in a variety of areas, and are assigned to numerous different fields of duty as circumstances warrant.

With the Colonial Operations Command, marines are responsible for assisting in planetary surveys and protecting colonists from dangerous local life forms. Until the organization and training of a local police force, they serve as police on the planet and on the colony ships.

Marines attached to the Headquarters Command act as sentries and honor guards at Star Fleet installations, as well as serving as bodyguards for planetary surface visits by distinguished civilians such as ambassadors, Federation secretaries, and commissioners.

Small numbers of marines are employed in the Galaxy Exploration Command, primarily to receive advanced training in diplomacy and other non-combatant skills. It is a great honor for a marine to be assigned to this command, and especially distinctive when the assignment is to an *Enterprise* or *Constitution* Class cruiser.

Marines are fairly common in the Merchant Marine, where they are used to reinforce security forces in boarding parties and planetside raids, enforcing Federation regulations and the confiscation of contraband. Other duties include serving as shipboard sentries over valuable cargoes and as escorts for prisoners.

The Military Operations Command is the most common area of marine service. Here, marines serve in garrisons along the Romulan and Klingon Neutral Zones. During peacetime, they also serve in defensive combat formations on hostile or potentially hostile planets, form training cadres on local defense units, and are available for controlling civil uprisings on Federation planets. During time of war, of course, they become the primary ground combat force of the Federation.

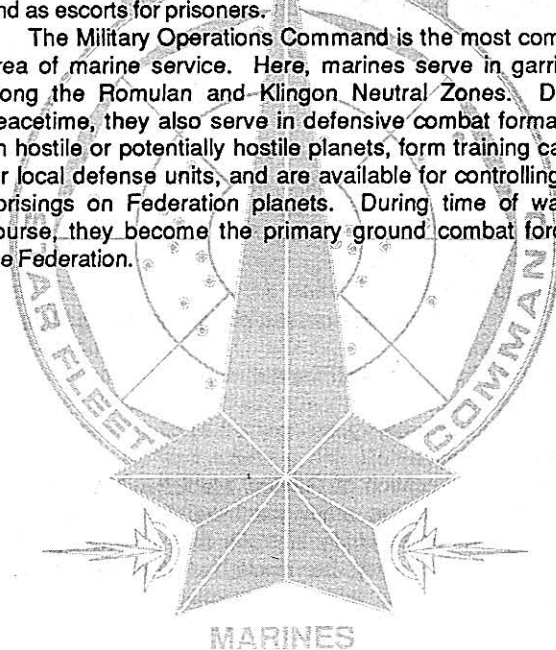

QUICK MARINE NPC CREATION TABLES

Rank/Title: Typical Marine Enlisted Man,
Recruit through Corporal

Attributes:

STR - 60 + 2D10 CHA - 40 + 1D10
END - 60 + 2D10 LUC - 1D100
INT - 50 + 1D10 PSI - 1D100 - 30
DEX - 60 + 2D10

Significant Skills

	Rating
Environmental Suit Operation	30 + 2D10
Marksmanship, Modern Weapons	40 + 3D10
Personal Combat, Unarmed	35 + 3D10
Security Procedures	10 + 2D10
Small Unit Tactics	20 + 2D10
Planetary Survival or Streetwise	10 + 2D10

Rank/Title: Typical Marine Noncommissioned Officers,
Sergeant through Warrant Officer

All attributes and skills same as Enlisted man, plus:

Any One Noncommissioned Specialty 45 + 3D10

Rank/Title: Typical Marine Officer,

Attributes:

STR - 55 + 2D10 CHA - 40 + 1D10
END - 55 + 2D10 LUC - 1D100
INT - 55 + 1D10 PSI - 1D100 - 30
DEX - 55 + 2D10

All Skills as Enlisted Man, plus:

Three to Eight Officer Specialties 20 + 2D10

(Three specialties for Sublieutenants, four for Lieutenants 1st and 2nd class, five for Lieutenant Commander, six for Commander, seven for Colonel, and eight for General or Marshal.)

Noncommissioned Specialties

Computer Operation
Environmental Suit Operation
Instruction
Language
Leadership
Marksmanship, Archaic Weapon
Marksmanship, Modern Weapon
Personal Combat, Armed
Personal Combat, Unarmed
Personal Weapons Technology
Planetary Survival
Security Procedures
Shuttlecraft Pilot
Small Unit Tactics
Streetwise
Vehicle Operation
Zero-G Operations

Officer Specialties

(all Noncommissioned Specialties, plus the following Skills:)

Administration
General Medicine, Native (First Aid)
Law, Federation
Negotiation/Diplomacy
Psychology, Native

With the exception of *General Medicine, Native*, marine officers may apply as many as three specialty rolls to a single skill, to substantially improve that skill rating. Only one specialty roll may be made for *General Medicine, Native*.

THE FIFE CONTINGENT

Normally carrying between 200 and 250 marines, the *Fife* currently carries 224, including Commandant Gray. Of the remaining 223 marines, one is a Lieutenant Commander, two are Lieutenants 1st class, three are Lieutenants 2nd class, and three are Sublieutenants. Forty-nine marine noncommissioned officers and 165 enlisted men make up the balance of the *Fife's* marine contingent.

Statistics for Commandant Gray and some other marines have been included among the **Cast of Characters**. If there comes a time when marines become actively involved, it may be necessary to generate additional marines. Up to 20 or 30 individuals might become necessary at one time or another, and the gamemaster might find it worthwhile to roll these up before the adventure begins, particularly if the *Fife* is to be a setting for future adventure situations.

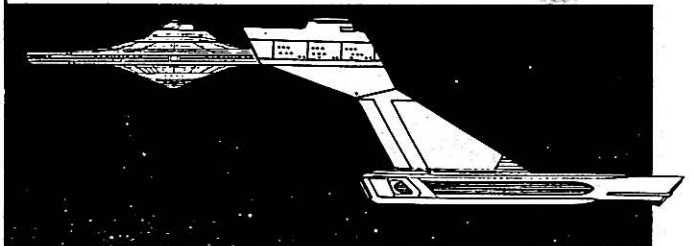

RANDOM ENCOUNTERS

COSMOS ROYALE ENCOUNTERS

Encounters may take place aboard the *Cosmos Royale* during the first portion of the adventure. The *Cosmos Royale* Encounter Table is used to determine which encounters take place, and exactly what happens. Resolution of each encounter depends on the actions of the player characters involved. For details, see **Aboard the Floating Crap Game** section in **The Adventure**. When multiple encounters occur, the gamemaster decides the order in which they actually occur. They may even come up simultaneously. The gamemaster should stage these situations dramatically.

COSMOS ROYALE ENCOUNTER TABLE

Die Roll	Encounter
1-50	No Encounter
51-75	Rioting Passengers
76-85	Security Guards
86-90	Hostage
91-95	Barricade
96-00	Whittaker's Ploy

Encounter Descriptions

No Encounter

No encounter takes place at this time.

Rioting Passengers

The characters enter a compartment where passengers have been rounded up awaiting transportation off-ship. The situation is tense and delicately balanced. Passengers

begin to clamor for an explanation, and the group's responses could trigger a major riot. If the player characters ignore the passengers, a riot immediately occurs. If they attempt to calm the crowd, any one officer may address them. If he makes a Skill Roll against his rating in *Negotiation/Diplomacy*, he defuses the riot; failure triggers it.

When a riot starts, each character suffers 1D10 hand-to-hand attacks before marines restore order. These attacks should be resolved without recourse to complex actions. Simply create random attackers (use statistics for Typical Bureaucrats found in the **Cast of Characters**) armed with stun clubs and police stunners. The game-master should create a stretch of corridor or compartments on paper and resolve the action in detail. Once the marines arrive, the encounter ends. If the guards capture the player characters, this leads to a Barricade encounter, with the player characters as hostages.

Hostage

A lone, armed man, hysterical with fear, has grabbed a young woman and threatens to kill her if he is not given a warp-capable ship and amnesty to leave the system. When this encounter is rolled, the player characters are informed of the event, and can take whatever action they desire. He can be attacked, but if he is not rendered unconscious or worse on the first shot, he will kill the hostage. While not devastating to the course of the adventure, this personal misfortune should be avoided. It is possible to try and talk the man out of the situation using a skill roll against the *Psychology, Human* rating as the base chance of success. This event can take place only once. If rolled again, treat this as No Encounter.

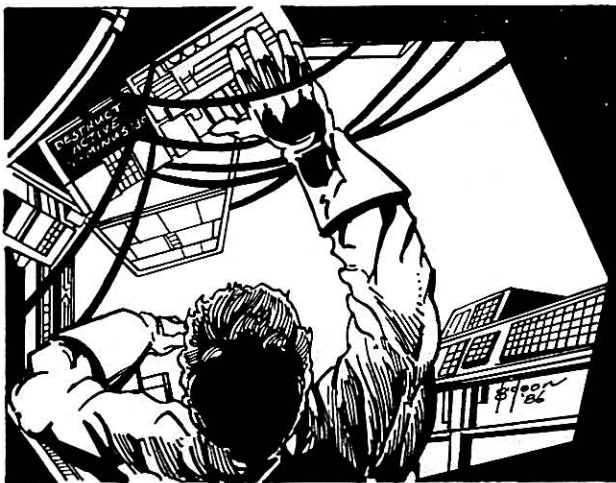

Barricade

The player characters are informed that a group of guards and passengers have holed up in a locked compartment and are refusing to come out. Reports are confused, but they may have hostages. It might be possible to bring them out by breaking into the compartment, but this could be a bloody solution if there are hostages. Alternately, a character can make a Skill Roll against his rating in *Negotiation/Diplomacy* to reason with them. Each failed attempt halves the chance of success on the next attempt and takes one full hour to resolve (mostly in discussions between the protestors). This result can be rolled only once, but can occur other times, if brought about through the Security Guard encounter.

Whittaker's Ploy

Perry Whittaker, Captain of the ship, cannot bear to see his precious liner destroyed, and goes off the deep end. He has been reported in the control room, where he was seen rigging some kind of electronic device to the ship's computer. This is, in fact, a bomb.

When the player characters reach the control room, Whittaker nearly has the bomb ready. If the Captain can make three Skill Rolls against his rating in *Electronics Technology*, the bomb will be activated on a 30-second delay. One roll may be made every turn in which Whittaker does nothing else. Rolls need not be successful on consecutive turns. If the bomb is activated, a player character needs to make only one Skill Roll against his rating in *Electronics Technology* to deactivate it within 30 seconds (three turns). If the bomb goes off, the computer is wrecked and will take an extra 2D10 hours to put into working order (over and above ordinary preparation times).

If Whittaker is stopped, he will break down, but will reveal the ship's computer access codes after sedation and truth drugs are administered. If this encounter never occurs, he does not panic, and turns over the codes voluntarily when the liner is completely secured. The encounter can take place only once.

DOOMSDAY MACHINE ENCOUNTERS

Each time a ship makes a combat run against the Doomsday Machine, and especially any time the Kirk Defense is under way, a single roll should be made on the Doomsday Machine Encounter Table. The result is implemented only if it is applicable to the situation. Thus, a transporter failure probably will not matter unless characters are beaming back from a ship on a countdown to self-destruction. Each ship rolls separately. Rolls are not made when the Machine is under manual control.

DOOMSDAY MACHINE ENCOUNTER TABLE

Die Roll	Encounter
01-40	No Encounter
41-60	Transporter Failure
61-70	Faulty Circuitry
71-80	Communications Breakdown
81-90	Panic
91-00	Machine Attack

Encounter Descriptions

No Encounter

No special event occurs.

Transporter Failure

This encounter applies only to the Kirk Defense situations. The transporters break down aboard the Kirk Defense recovery ship. One skill roll to repair them (using the *Transporter Systems Technology* rating of any single character aboard the recovery ship) is allowed every two minutes from the moment the destruct system is activated. Transport is not possible until the repair is made.

Faulty Circuitry

This encounter applies only to Kirk Defense situations. The self-destruct timer mechanism fails to activate when armed. It may be fixed by a character who announces his intention to do so, and makes a Skill Roll against his rating in *Electronics Technology*. One roll is allowed every two minutes, but each failure requires an additional encounter roll. As subsequent encounter rolls are made, there is a cumulative modifier of +10 per roll. Even if the first repair roll is a success, a second encounter result (with the +10 modifier) must still be checked.

Communications Breakdown

All contact between the rolling ship and other ships is lost. Without communications, transporters cannot lock onto and beam people over. Also, coordination of attack runs (see *Buying Time* in *The Adventure*) will not be possible.

Panic

The Doomsday Machine is an awesome sight, and the view down its maw is like a look straight into the Pit. Characters can break down under the strain, and fail in their duty.

If this result occurs, any character in a position to view the Machine and who is required to perform a skill roll or other task, must make a Saving Roll against his INT score. If he fails, the character freezes. The task or skill roll is not carried out, with fairly disastrous consequences.

Machine Attack

If this event occurs, the Machine gets an automatic attack with its anti-proton beam on the ship in question, regardless of skill rolls made, ranges, or anything else. The Machine brain does have a certain random-number control over behavior patterns, and can throw in a wild shot or two from time to time.

THE DOOMSDAY MACHINE

"I can't help wondering if there are any more of these weapons wandering around the universe." So spoke Lieutenant Commander Spock at the conclusion of the *STAR TREK* episode "The Doomsday Machine". This adventure answers Spock's question. The *Players' Handout* details all that is known by Star Fleet about the Machines at the start of the adventure. The following discussion reveals some aspects of the situation not known to the Federation, but useful in gamemastering the adventure.

ORIGINS

Roughly three billion years ago, in a distant galaxy, two races faced one another in a struggle for survival. Their technologies and military strength were roughly equivalent, and they were about a century ahead of the Federation in terms of scientific achievement. They had developed total mass-energy conversion (as opposed to the relatively inefficient matter-antimatter conversion process used by the UFP) and the development of anti-proton beam weaponry. Equipped with such weapons, each side was in a position to destroy the other.

At least one of the two races set out to develop what they saw as a deterrent to total war. These deterrents were Doomsday Machines, immensely powerful computer-controlled vessels that were, in effect, giant anti-proton guns hooked to mass converters and encased in solid neutronium armor. Many such Machines were built, and placed to defend the inhabited worlds of their masters. Inert and harmless, they orbited silently, awaiting orders to carry out their mission.

That mission was one of retribution. In theory, no Doomsday Machine would attack unless someone tampered with or destroyed a fail-safe device, which was generally placed in orbit near the Machine itself, or on the planet it protected. In an attack, the destruction of the beacon pod (or the active intervention of one of the defenders) could activate the Machine. The beacon was also used to gain access to the Machines for purposes of servicing, or to place a crew on board temporarily (such as when deploying the Machine to a new site).

Unless disarmed by the proper service personnel, the activated Doomsday Machine was programmed to destroy. A kind of primitive Von Neumann machine, it could operate indefinitely, cutting up planets with anti-proton beams to feed the mass conversion furnace, then stockpiling energy to charge the beams, a powerful but ponderous transwarp drive system and the ship's computer. The Machine's programming was simple: seek out any planets and destroy them, react to nearby threats in the most efficient manner possible, and pursue the programmed goals until shutdown or destruction. Doomsday Machines were nearly invincible. Even another Doomsday Machine's anti-proton beam could not penetrate the neutronium armor of one of the giant cylinders (though a shot right down the maw or the detonation of a powerful explosion in the furnace area could destroy a Machine's working parts).

Despite the deterrents (or perhaps because of them), the final war eventually began. Once one Machine was activated, it was inevitable that most of the others would follow suit, because the Machines do not discriminate between friends and foes, save when specifically stopped by a beacon. In the confusion of the conflict, few could be shut down, and the Machines devastated both empires.

Some Machines found their way out of the home galaxy. Those that were activated went to a standby, minimum-power status when fuel supplies ran low, drifting until they passed close to a planet and were revived by computer control. Others, still deactivated, were hurled from their original orbits by accidents of various types. Often, their beacon pods remained with them, as was the case with the Machine found in this adventure.

The discovery of the Machine by O'Flaherty is substantially as discussed in the section of *The Adventure* entitled *Beacon of Hope*. Other information regarding the origin and background of the Machine is unlikely to come to light.

THE BEACON POD

The beacon pod was designed as both a fail-safe mechanism and a key for the Doomsday Machines. It is a large and complex mechanism capable of defending itself (to a limited extent), and designed to communicate with and activate a single Machine. Powered by a small total-conversion furnace, a beacon pod's power requirements are so low that the interstellar gas and dust can keep it on standby almost indefinitely. Its only real power drain comes when it must operate weapons, propulsion, or communications systems, and these come into play only in very unusual circumstances.

The tractor beam is used to draw matter to the vicinity of the pod, then the propulsion system fields suck particles into the wide end of the cone. The tractor is also used to lock onto the Machine's airlock mechanism and draw the pod into the lock circuit.

On-board communications and computer systems are simple, but technologically advanced. The beacon can be activated manually or by a specially-coded communications signal, but these codes will not be available to the characters. When the beacon is partially activated, it transmits signals that start up the Machine to which it is keyed. When fully activated by entering the proper code sequence, the beacon allows close approach and safe docking, plus access to the Machine's service airlock. It takes about ten minutes for the Machine to switch over to the programmed pattern of behavior that unleashes it against planets. In that interim, a service crew would have time to board the Machine and execute manual overrides. All aspects of

beacon and Machine operation hinge on a dead-man principle: once turned on, the Machine must be stopped or it automatically carries out its ruthless mission. This is quite different from the fail-safe procedures of Federation worlds.

The pod's weapons system is designed to ward off unauthorized intrusion. It will fire on the largest target within a 50-kilometer radius if it detects the nearby use of sensors, transporter beams, weapons, or other activities that the on-board computer might interpret as potential tampering. Again, the transmission of proper authorization codes can override the system.

The beacon in this adventure has had its weapon system damaged by phaser fire. Its builders were accustomed to the use of considerably more powerful weapons (even handguns), and did not allow for a mere disabling hit. Any hit that would destroy the beacon would also trigger the activation of the beacon's Machine, another dead-man switch application.

MACHINE BEHAVIOR

When activated, a Doomsday Machine follows extremely simple rules.

On-board navigational systems always lock on to the nearest stellar body. The Machine moves under transwarp drive to that system, but at a very slow FTL speed. Even transwarp engines have trouble moving the huge mass of the Machine. Scanners then lock on to the planetary bodies of greater than about 350 kilometers diameter, and proceed to guide the Machine to each in turn. When there are no planets within a range of 50 astronomical units (about 7,500 billion kilometers), the Machine searches for the next nearest star system. Any time an object of less than 250 kilometers diameter (including carved-up fragments) is detected within 3,000 kilometers range (one hex, if using the *STAR TREK III: Starship Combat Role Playing Game*) it is drawn by the tractor beam into the Machine's maw and fed into the conversion furnace. If the Machine is fired upon by energy weapons, it will respond by returning fire with the anti-proton beam.

The Machine is effectively immune to all attacks that strike the neutronium hull. Even a shot directly down the maw with conventional energy weapons does little damage. Explosions set off inside the furnace have a chance of disabling the Machine, including explosions caused by missiles, photon torpedoes, plasma torpedoes, and similar weapons.

Normally, the chance of deactivating the Machine is figured as a percentage based on the power of the explosion. The number of power points used to arm the missile or to power the vessel used as a bomb yields the percentage chance of deactivation. When Captain Kirk used the *USS Constellation* in this way, he had a base chance of 48 percent of destroying the intruder. Firing photon torpedoes would have given a one percent chance of success. A Mark II Romulan plasma torpedo would have a base chance of 15 percent to destroy the Machine, if it were detonated at close range.

The problem with missile attacks is that they require the attacking ship to fire from directly in front of the Machine's maw, in easy range of the device's anti-proton and tractor beams. The chance of success is low, and cannot be increased in any way. Using a starship as a bomb, the Kirk Defense is preferable by far. Not only is the base chance higher for larger ships, but the chance can be increased further by preparatory die rolls and by luck. After each hour a character spends preparing the ship, have him make a Skill Roll against his rating in *Warp Drive Technology*. If successful, add five percent to the base chance. If the LUC score of the detonating officer is at least 71, add another five percent. No matter what, the percentage modifier cannot be raised above 25 percent.

In this adventure, the gamemaster will condemn to failure the Kirk Defense attack with the *Cosmos Royale*. After all, just because Kirk was lucky, there is no reason why the players have to be. Additionally, failure of the first attack opens up new and even more challenging situations.

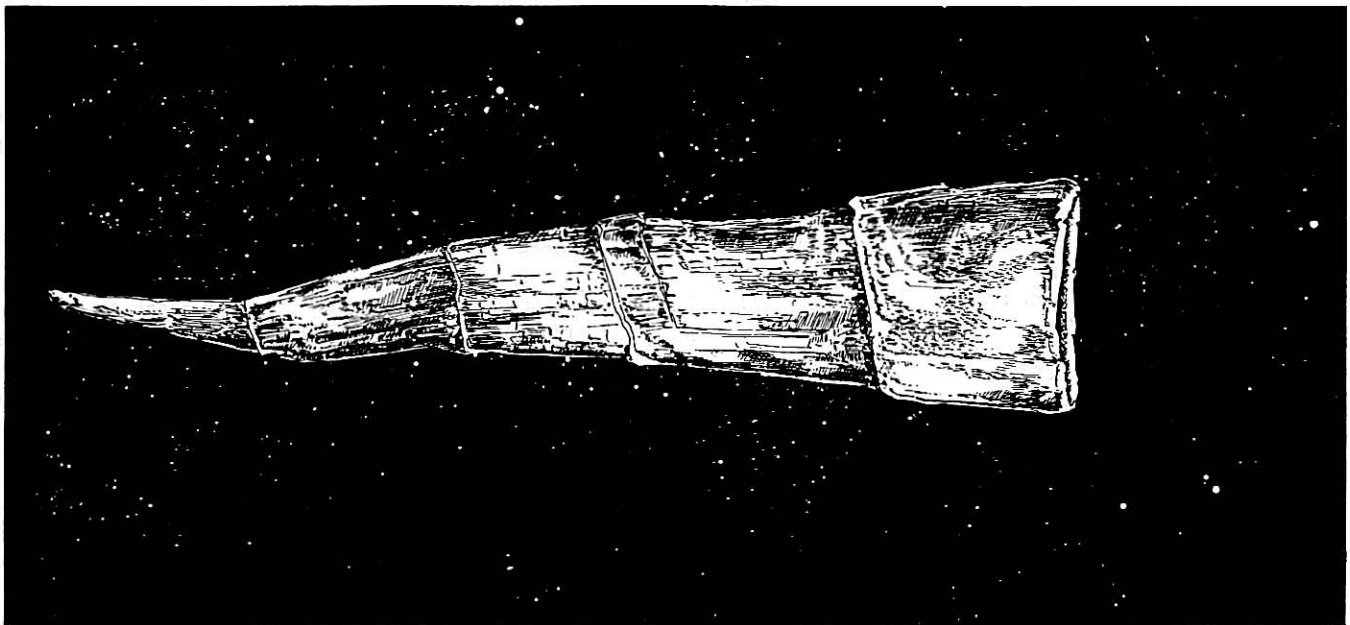

PLAYERS' HANDOUT

The Captain may read the briefing material contained in the following pages. He is free to show or withhold this material from the other players. The miscellaneous information is contained in ship's computer files, and any player characters can study them.

DOOMSDAY MACHINE

Popular name for a robot-controlled, space-going weapon first encountered in Stardate 2/0802 by the *USS Constellation*, Commodore Mathew Decker commanding. Decker's ship was severely damaged in the encounter. After being beamed to the surface of a nearby planet to escape the failing starship, his crew was killed when the planet itself was destroyed. Decker remained aboard ship until assistance arrived.

The *USS Enterprise*, Captain James T. Kirk commanding, was dispatched to investigate the *Constellation's* disappearance, and also encountered the weapon. Taken over by Commodore Decker in accordance with Star Fleet regulations, the *Enterprise* engaged the Machine unsuccessfully, and was caught in a tractor beam. Commodore Decker attempted to use a shuttlecraft as a bomb, but was killed. Kirk followed up on this idea, however, by setting a destruct mechanism on board the *Constellation* and exploding it inside the Machine, which became deactivated. Unfortunately, the weapon's course carried it into a nearby sun before a Star Fleet salvage operation could be mounted. Thus, all information available on the Doomsday Machine comes from the report filed by Captain Kirk in 1/0803.

SPECIFICATIONS

The Doomsday Machine is an irregularly-shaped cone. It is 10,115 meters long. Diameter at the mouth of the cone is 1,686 meters, which tapers to a mere 171 meters at the stern. Approximate weight is 2,352,500,000 metric tons. Its hull is composed entirely of neutronium, the dense material formed out of collapsed stars. Readings taken by the *USS Enterprise* during its encounter with the Machine suggest that it is some three billion years old and extragalactic in origin.

The design of this weapon is quite simple. Its wide end is the Machine's bow, and is open to space. No other openings of any kind were detected. The maw leads directly to a high-energy total-matter-conversion furnace, and is also the channel through which an anti-proton energy beam and an extremely powerful tractor field are directed.

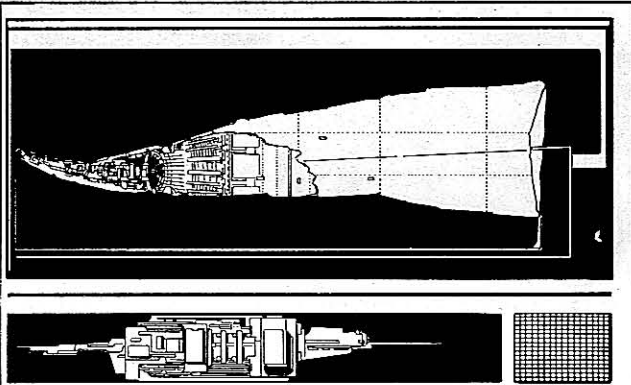

The Machine is evidently computer-controlled, and capable of an indefinitely long period of operations. It is capable of warp speeds, though details of its propulsion system are not known. The conversion furnace powers all systems, and is fed by breaking up planets (using the anti-proton beam) and ingesting the fragments with the tractor beam.

The anti-proton beam is an extremely potent offensive weapon, capable of overcoming any Federation-developed deflector shield. The Kirk Report shows that one shot by this weapon, though partially offset by the FSO-type shields aboard the *Enterprise*, caused some minor damage. Three shots knocked down the shields and caused heavy damage, while more would have rendered the ship useless, which is what happened to the *Constellation*.

No known weaponry is capable of damaging the outer hull of a Doomsday Machine. It is completely impervious to phasers or photon torpedoes. Subsequent studies by Star Fleet Command have determined that the neutronium hull can withstand the most powerful, best-placed hit by the Romulan plasma torpedo, which is acknowledged to be the most effective weapon in known space. The interior of the Doomsday Machine is vulnerable to explosions, but required energy outputs for such an explosion are tremendous. See also files on the so-called Kirk Defense.

ORIGINS

All opinions as to the origins of the Doomsday Machine are based on the theories and speculations advanced in the Kirk Report. Though based on all possible data and the reliable analysis of Kirk's Science Officer of the time, Spock of Vulcan, these remain highly speculative assumptions at best.

It is believed that the Doomsday Machine was the product of an advanced culture based in a distant galaxy (best estimates place its technological level at least 50 to 100 years in advance of current Federation standards) about three billion years ago. It is likely that this robot weapon was, as its name implies, a device intended to ensure peace by guaranteeing the annihilation of an aggressor, even after its builders were destroyed. If so, the guarantee of peace proved to be useless, and there was a war that ultimately caused the Machine to be lost. It continued to search out new targets for destruction, even across intergalactic space, until it was destroyed by the *Enterprise*.

In his addendum to the Kirk Report, Science Officer Spock suggested that the logical corollary of the first Doomsday Machine encounter suggests the existence of at least one other such Machine, as the threat that would cause one to be built implies that another culture had the capability to construct a counterpart.

In his graduate thesis at Star Fleet Academy, Commander Sonak of Vulcan (deceased) advanced the theory that there may actually have been many more such weapons in the arsenal of each of the contending powers. They certainly realized the essential vulnerability of the Machines to what came to be called the Kirk Defense, and they were probably involved in a form of arms race to ensure that some of the weapons would survive a first strike by the enemy. Setting aside Sonak's bias against militarism and

the proliferation of weaponry among emotionally-violent species, this thesis attracted considerable attention in Star Fleet circles, and was one of the factors that attracted Admiral Kirk's interest in Commander Sonak up to the time of the Vulcan's unfortunate death in a transporter accident.

STAR FLEET ADVISORY

All ship Captains are advised that the existence of additional examples of the Doomsday Machine is a possibility that cannot be ignored. Standing orders in the event of contact with a Doomsday Machine are as follows:

1. The primary duty of all Star Fleet personnel in the event of encountering a Doomsday Machine shall be to render said Machine harmless through any means at their disposal.

2. The lives of civilians and the protection of Federation worlds are to be considered of paramount importance.

3. When encountered and rendered harmless, the Doomsday Machine is to be kept out of the hands of unfriendly powers capable of profiting from study of the Machine's technology, except where adherence to this directive would conflict with either of the first two directives.

4. When encountered and rendered harmless, the Doomsday Machine is to be preserved for study by UFP scientific teams, except where adherence to this directive would conflict with any of the first three directives.

5. Any ship or vessel that contacts a Doomsday Machine is instructed to gather all possible scientific information regarding the Machine's origins, capabilities, and behavior, and transmit same to the nearest star base or other Star Fleet facility, except where adherence to this directive would conflict with any of the first four directives.

6. Where possible, the Kirk Defense (q.v.) is to be attempted as a method of deactivating a Doomsday Machine. Star Fleet personnel are authorized to use whatever means necessary to carry out these directives, within the limits of judgement, and in accordance with normal Star Fleet and Federation laws and procedures governing the use of Star Fleet authority with civilian, governmental, and foreign persons or bodies.

In the event that the Kirk Defense proves unfeasible or unsuccessful, and in the absence of other alternatives, Star Fleet personnel are ordered to make any sacrifice of equipment or lives essential to the achievement of the primary duty.

ECTAIR

Ectair is the fourth planet of Mozinphar's Star. An independent world lying within the Federation sphere of influence, Ectair was settled sometime before Stardate 2/0001. The original colonists were Orion political refugees led by Emerak Mozinphar. Since that time, various other groups have joined the colony. The world has maintained a strong tradition of complete independence, and is a trade-world with a reputation for minimal concern for legalities. By treaty, it is also an open port of call for Romulan vessels.

In-depth planetary information is available.

IFF TRANSPONDER

The IFF transponder was a signalling system used to identify ships prior to the introduction of current computer/sensor scanning techniques. The transponder principle originated on Terra during the mid-20th Century. Transponders were designed to receive recognition signals on a certain frequency, and to respond in kind. Coded signals broadcast by sophisticated transponders could identify the ship in detail, making it possible for weapons systems to discriminate between friendly craft and potential targets. The last use of transponder systems by Star Fleet was during the Romulan War. During that conflict, sensor scan technology advanced to the point where ship recognition could be accomplished by long-range sensors that processed not only ship origins but also the nature of life-forms aboard and other key bits of recognition data. Computer control was sophisticated enough to program this into all weapons systems. Transponders continue to be used for purposes of broadcasting basic registry information for civilian craft, but are obsolete in current military arsenals.

KINGLINES

Kinglines is an interstellar transport firm headquartered on the free trade world of Ectair. A privately-owned company, Kinglines' founder, president, and chief operating officer is Burton King. The company has constructed one ship, the *MS Cosmos Royale*, rated at 146,115 metric tons and launched in 2/2112.

Kinglines' Stock Profiles Code is 3E20.

KIRK DEFENSE, THE

This is the name given to the maneuver used by Captain James T. Kirk of the *USS Enterprise* to defeat a Doomsday Machine in Stardate 2/0802. This maneuver prescribes tactical doctrine for Star Fleet Commanders faced with a similar situation.

The Kirk Defense calls for the use of two vessels of Class IX or better. One ship is used strictly as a command and recovery vessel. The other ship, stripped of all crewmembers and rigged for fusion-triggered engine of self-destruction, is to be piloted so that it is caught in the Doomsday Machine's tractor beam and pulled into the weapon's interior. The destruct sequence is completed at this time, and the ship detonates. Vital non-neutronium components within the Doomsday Machine are consumed by this blast, deactivating the weapon.

The Kirk Defense was proven to work by the detonation of the engines of the *USS Constellation*, which deactivated the first Machine. However, subsequent analysis of *Enterprise* data and science logs indicates the possibility that the explosion of even moderately-sized vessels inside a Machine may not always be sufficient. Size of engines used (in power output) is very likely directly linked to effectiveness, and Star Fleet recommends that the largest possible ship be used in any situation of this type.

NEUTRONIUM

A super-dense element found at the heart of collapsed stars, neutronium is a rare and extremely tough substance. Federation technology is not yet up to the manipulation of neutronium as a structural material. The builders of the Doomsday Machine (q.v.) are known to have used it. As armor, neutronium is resistant to almost any form of energy or matter, and is impervious to all weapons known to contemporary technology.

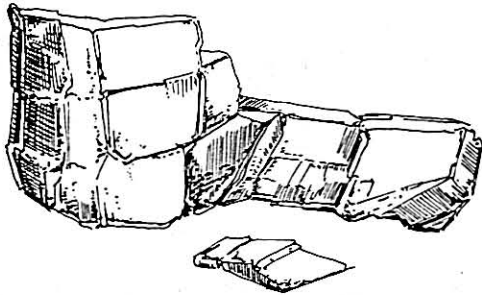

OUTBACK, THE

The Outback is the popular name for that section of space along the Federation frontier between the Romulan Neutral Zone and the Clanhaven Treaty Sector, including the border worlds of the Federation and the territory beyond. Although Federation Intelligence is not certain of the exact boundaries, the Outback is believed to include a wide band of uncontrolled stars between the Romulan Star Empire and the Gorn Alliance.

Federation presence in the Outback region has been limited to the consolidation of the UFP sphere along the frontier. It is believed that both Romulan and Gorn expeditions into the Outback are fairly common, and the area is considered a potential trouble spot as a result of their presence.

TREATY OF ECTAIR, THE

Interstellar accord signed on Stardate 2/1810.21 by representatives of the United Federation of Planets, the Romulan Star Empire, and the independent tradeworld of Ectair. The treaty arose from the discovery that Romulan vessels cruising in the Outback were encroaching on Federation-claimed territory, a presumed violation of the Romulan Peace Treaty. For their part, the Romulans claimed that their ship had not crossed the Neutral Zone, but had travelled around it by way of the region known as the Outback. Ectair's interest in the matter stemmed from the fact that they were making a modest profit from Romulan trade, and wished to see it continue. As Ectair was the point of first contact between Star Fleet personnel and the Romulan 'intruders', the negotiations were held there.

The terms of the treaty can be summed up as follows:

1) The presence of Romulan vessels in territories outside the limits of the Star Empire is permissible and does not violate the original peace treaty.

2) Romulan vessels may not cross the Neutral Zone, nor may they come within five light years of any inhabited Federation planet or defense outpost. To do so is considered a treaty violation and grounds for hostilities.

3) Romulan vessels are allowed free access to any independent planet that welcomes their presence, provided they do not violate the second treaty provision to do so.

4) Federation vessels are granted permission to obtain supplies and authorize shore leave on Ectair.

5) Both the Romulan Star Empire and the United Federation of Planets agree to preserve the integrity of the independent government of Ectair.

The Treaty of Ectair is considered by many to be a major diplomatic victory for the Romulans, who in one stroke of the pen regained the freedom (lost after the Romulan War) to operate vessels beyond (but not across) the Neutral Zone. In point of fact, they had already been doing so for many years, but the Treaty represents the legalization of this situation. This Treaty marks the downfall of the strong anti-Romulan movement that had previously enjoyed considerable popular support.

Subsequent Federation policy has called for consolidation of the Federation presence in the region, the annexation of additional territory when practical, and the strengthening of border defenses. For the moment, Ectair continues to enjoy the benefits of trade with the Romulans, and refuses all attempts by Federation diplomats to forge closer ties as a prelude to absorption.

EXTRACT FROM COMMAND ORDERS FOR *USS FIFE*, NCC 2572

III. You are therefore posted, effective immediately, to command the following:

The USS Fife

Frigate, Class XI — 177,500 metric tons

Crew Complement — 370 crewmembers

250 marines

Drive — space — warp

Range — 15 years at light-year velocity

Registry — Terra, United Starship

IV. Nature and duration of mission:

Military Operations Command: 1 year

V. You will conduct the patrol to accomplish primarily:

1. UFP frontier security (see Appendices C and E, these orders; and

2. Any required assistance to the UFP colonies in your quadrant, and the enforcement of appropriate statutes affecting such Federation commerce vessels and traders as you may contact in the course of your mission; and

3. Scientific investigation of alien life forms and social systems encountered in the course of your patrol.

VI. On receipt of these orders, you will report to the Commandant of Star Base 8 for patrol parameters and operational orders. You will remain under the authority of Commandant Star Base 8 until reassignment or termination of your present mission. In the course of your patrol, *USS Fife* shall be assigned to independent duty, and you are therefore expected and required to exercise command initiative as necessary to the successful performance of all General and Specific Star Fleet Military Operations.

APPENDIX C INTELLIGENCE SUMMARY ROMULAN ACTIVITY SECTORS SE1-4/8-9

GOALS AND OBJECTIVES

Data on Romulan activities in the Outback region is sketchy. The bulk of UFP Intelligence work has been concentrated on the Triangle region at the other end of the Neutral Zone, and so does not cover all of the Star Empire's widespread interests.

Romulan presence in the Outback has been confirmed since the encounter of 2/1705, in which Federation and Romulan ships met one another in the neutral Ectair planetary system. The Romulans claim (and most evidence gathered so far tends to support them) that their interest in the region is purely oriented toward exploration and scientific research, with a strong mercantile presence being a secondary but fairly significant factor. Settlement and/or conquest of the region is of course a probable intent, this evidently being a prime racial goal of the Romulan people.

Star Fleet Intelligence has produced no proof to support the widespread belief that the Romulans are exploiting the area with the intent of developing a major military base for operations on the flank of the Neutral Zone border outposts. In view of recent improvements in diplomatic relations, minor though they may be, it is possible that no hostile action is being contemplated in these quadrants. Lack of evidence, however, does not rule out the possibility of a Romulan military buildup, and all patrolling Federation vessels are urged to be prepared for possible hostile encounters. Any encounters that suggest the presence of a Romulan base in the region are to be investigated, and information forwarded to Star Fleet Operations/Military Operations Command/Romulan Desk.

Intelligence reports suggest that Romulan ships may have been lost in the Outback region, possibly to Gorn action. If so, this may account for Romulan interest in the region, and suggests the possibility of an unstable local situation. Star Fleet vessels are to avoid hostile contact

with Romulan forces in the area, except where self-defense makes such an encounter unavoidable. Under no circumstances are Star Fleet vessels to act in a manner that might cause Romulan leaders to assume Federation involvement in any Star Empire losses in the region.

In the event of hostilities between Romulan and Gorn forces in the Outback, Star Fleet vessels are to maintain strict neutrality. Humanitarian considerations call for the rescue of personnel of any race in danger of death, but intervention in hostile encounters is authorized only as necessary to protect the lives and property of UFP citizens, allies, or protectorates.

PRESENCE

No current estimate of Romulan numeric strength in the Outback is available. All data on file is based on actual observation, inference, and theory, and is certainly incomplete.

Reportedly, Romulan military/research operations in the region are built around the use of naval squadrons. At least four such squadrons, each numbering three to six ships, have been identified as operating in the Outback. One of these, estimated strength of five ships, is believed to be engaged in exploration of worlds within six parsecs of the UFP border. Encounters with Romulan military ships have twice been reported inside the border, but in both cases, these have been in deep space outside the five-light-year-limit. It is highly probable that Romulan ships are engaged in intelligence-gathering activities in UFP space, as well as open exploration. Star Fleet patrol vessels meeting Romulans in deep space are not to engage the ships until and unless the Romulans commit a hostile act or violate the five-light-year-limit of any system that is a part of, allied with, or protected by the Federation. Encountered Romulan ships should be followed while within Federation space to ascertain their purpose and destination, but engagement other than in defense of Federation right or property is expressly forbidden.

Should Romulan ships be engaged, priority is to be given to the capture of an intact, working cloaking device. However, such capture is not to be attempted if Federation security is jeopardized in doing so.

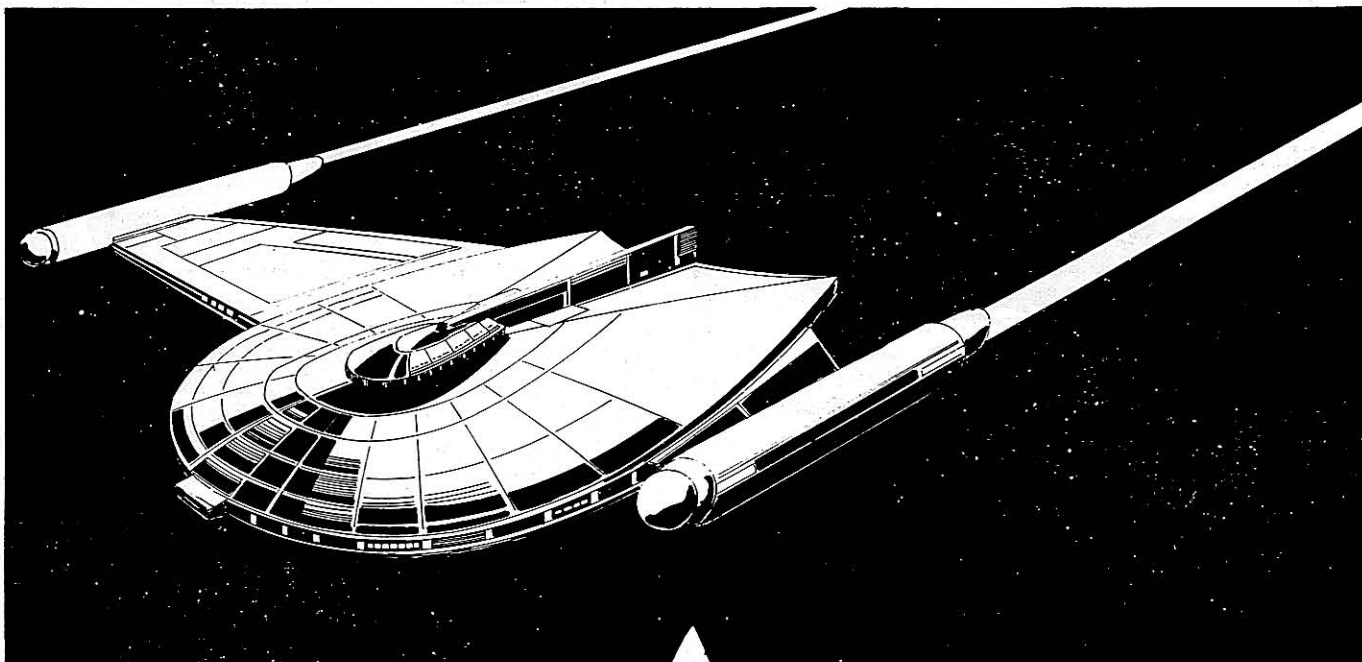

**APPENDIX E
INTELLIGENCE SUMMARY
GORN ALLIANCE ACTIVITY
SECTORS SE/1-4/8-9**

GOALS AND OBJECTIVES

It is believed the Gorn Alliance lays claim to a fairly extensive portion of the Outback region. As is generally the case with the Alliance, however, their claims considerably outreach their actual, physical colonization and control. Ambassador M'krew of Cait, current head of the Clanhaven negotiating team, has reported that there are indications of increased Gorn commitment to this area of space, evidently at the behest of the moderate factions within the Alliance. It is fairly clear that Gorn expansionism is being turned away from the UFP frontier, and the Outback would appear to be an area of some importance to the Alliance at this time.

The fragile state of current UFP-Alliance relations is not to be jeopardized, and violation of Gorn-controlled space is to be avoided to circumvent the possibility of any repetition of the Cestus III incident. Star Fleet vessels are to prevent Gorn encroachment on Federation-claimed space; peacefully, if possible. Any dispute is to be referred to Clanhaven, but, as always, the first mission of all Star Fleet personnel is the security of the UFP.

The Gorns are believed to have come in contact with the Romulans at some point in the past, and the possibility of conflict between these two groups is not to be overlooked. Cf. Appendix C for further guidelines.

PRESENCE

The extent, size, organization, and location of Alliance forces in these quadrants are not known. It is believed that most ships committed to this region are of older and less useful designs, but this is not certain. The fact that Romulan ships may have been lost to the Gorns over the past several years suggests that the Gorn commitment to the area is neither small nor weak in combat strength.

Any Gorn activity in the Outback that may give further insight into their overall goals, objectives, and philosophies is to be investigated, without violation of Gorn territorial integrity, and reported to the attention of Ambassador M'krew.

**APPENDIX H
BUREAU OF FOREIGN RELATIONS
GUIDELINES: ECTAIR**

The following guidelines apply to all dealings with the government and population of Ectair (Mozinphar's Star IV).

1) Star Fleet vessels are to observe the integrity of Ectair's internal affairs at all times. The independence and self-determination of the planet are to be of first importance in any dealings with the planetary government.

2) As an independent world, Ectair is not subject to the treaty provisions prohibiting Romulan vessels within five light-years. Romulan ships have the right to call at Ectair, and are not to be molested within Ectairian space.

3) The Federation citizens who compromise a significant portion of Ectair's population are to be extended the protection and assistance of Star Fleet, but only where this does not jeopardize planetary relations.

4) Any and all opportunities to assist the government of Ectair, where such assistance is requested and/or approved by the Ectairian government and falls within approved Star Fleet policy, should be taken by Star Fleet officers.

5) The Federation Consul on Ectair, Aki Torimatsu, is responsible for all UFP citizens on the planet, and may be contacted at need for further advice and assistance in dealing with the government of Ectair.

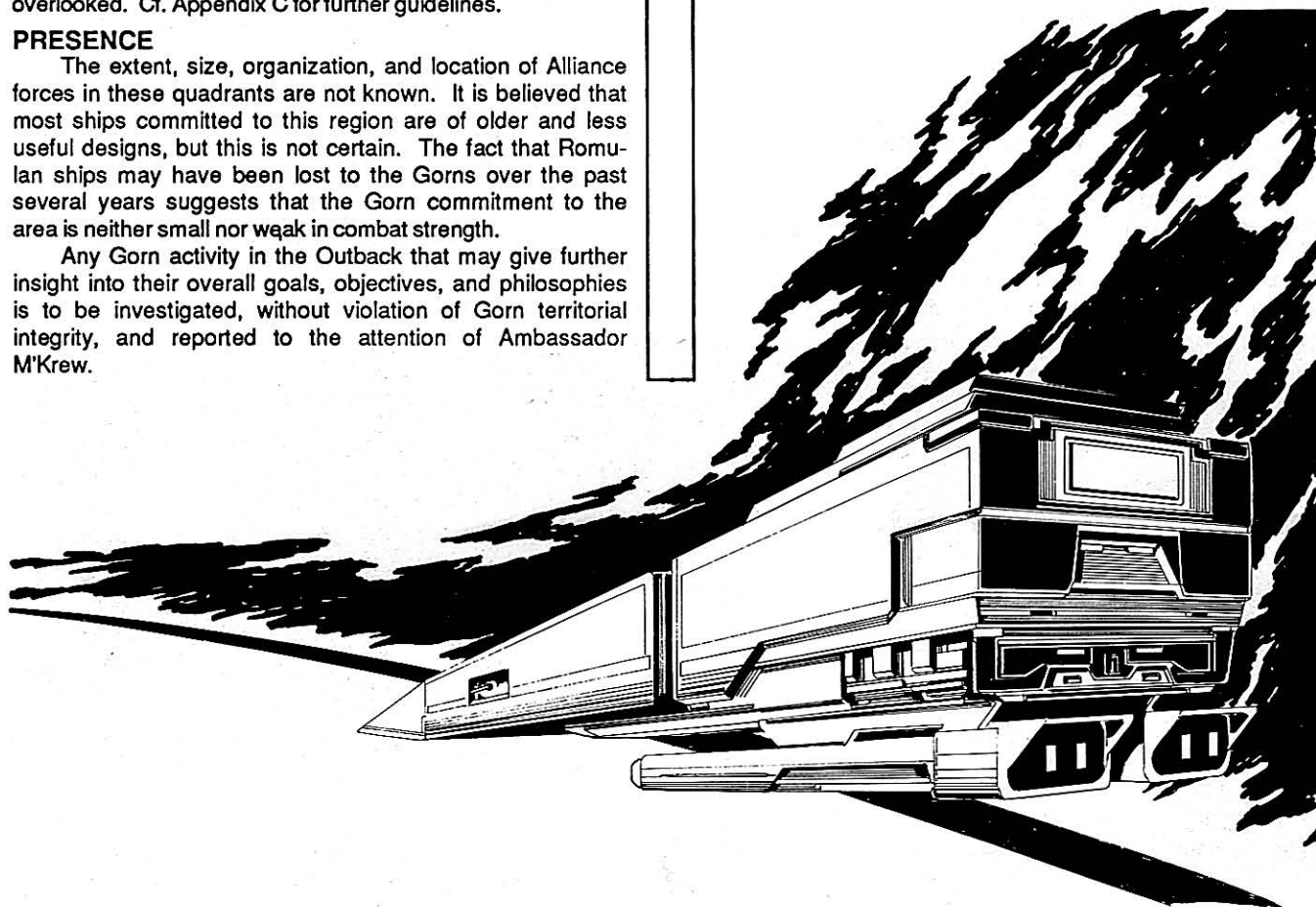



It was a dull patrol, and the officers and crew of the frigate *USS Fife* were tired of the routine, tired of watching an empty frontier. Then, a call for help put the *Fife* face-to-face with the most implacable foe ever faced by Star Fleet—one of the robot-brained "Doomsday Machines", like the one destroyed years before by the *USS Enterprise*.

As if that weren't enough, the *Fife* had to contend with panicky civilians, selfish VIPs, interfering Romulans, and a colorful rogue whose surprising cargo might hold the only hope of stopping the planet-crushing juggernaut. It would be a day they all would remember... but it certainly wouldn't be **A Doomsday Like Any Other**.

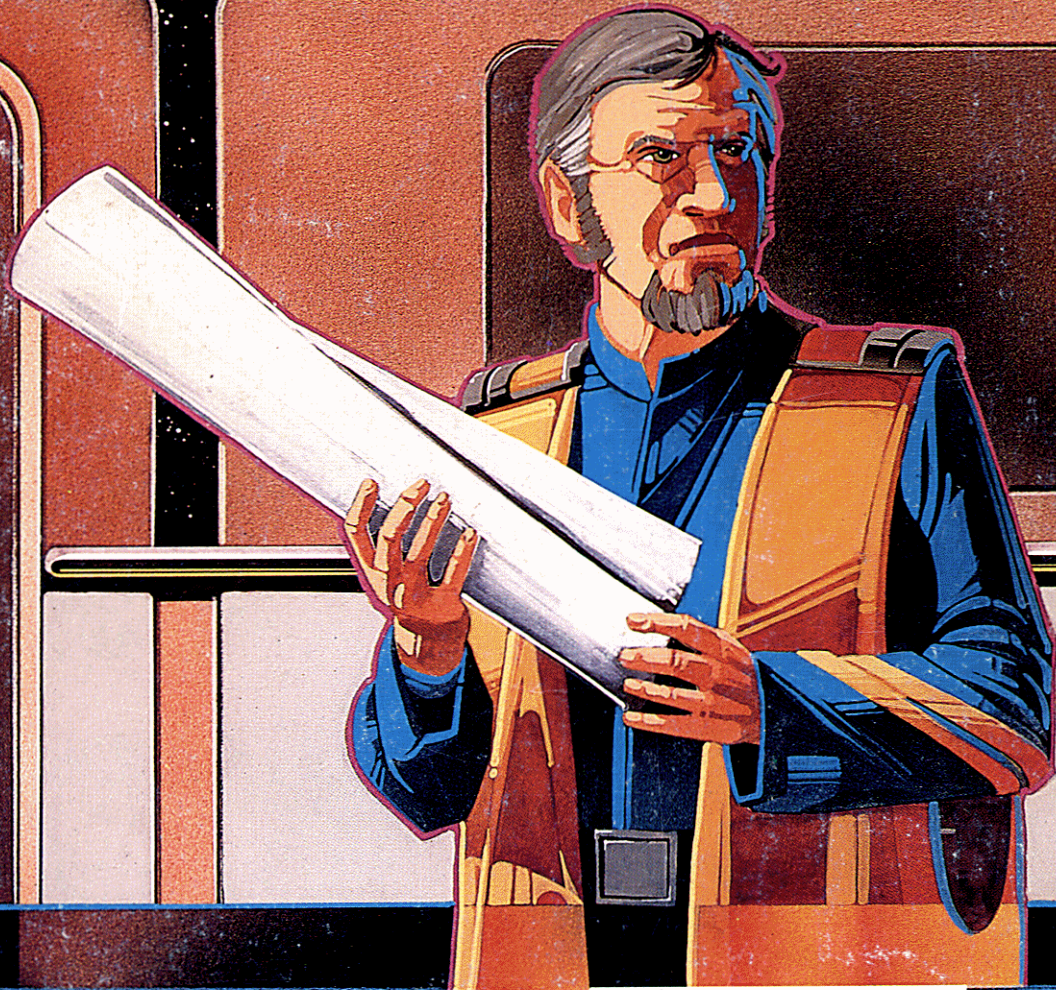

0



8

ISBN 0-931787-22-4 FASA800

STAR TREK is a trademark of Paramount Pictures Corporation.
STAR TREK: The Role Playing Game is published by FASA Corporation under exclusive license from Paramount Pictures Corporation, the trademark owner.
Copyright © 1986, 1986 Paramount Pictures Corporation.
All Rights Reserved. Printed in the United States of America.